





Möwee es una
actitud. Elegante.
Sensual. Viva.
Espacios outdoor donde
sentirse como en casa.



Möwee forma parte del trabajo, esfuerzo y compromiso de Gaviota, empresa líder en el sector outdoor. Nace para ampliar horizontes en el mundo del mobiliario de exterior, de forma independiente. Con un carácter marcado por su forma de ser y de hacer. Frescura, sencillez, calidad y diseño son el corazón de su ADN.

Möwee is part of the work, effort and commitment of Gaviota, a leading company in the outdoor sector. It was set up as an independent venture to broaden horizons in the outdoor furniture world, with its own distinctive character and way of doing things. Freshness, simplicity, quality and design are at the heart of its DNA.

ESSENCE MÖWEE



Sentimos la necesidad de hacer propio aquello que nos rodea. Objetos con significado, diseños con alma, piezas que reflejan nuestra personalidad, o que simplemente nos hacen sentir. Necesitamos hacer de cualquier espacio, nuestro oasis particular.

Möwee más que una marca, es una actitud. Elegante. Sensual. Viva. Su objetivo es crear espacios outdoor donde sentirse como en casa, aportando un toque original, fresco y con personalidad. En constante innovación, con la creatividad como estilo de vida. Cada colección, es una declaración de intenciones. Seducir a través de los sentidos y conquistar con los detalles. Diseño de vanguardia y fabricación propia, de principio a fin. El resultado es nuestra razón de ser, la esencia que nos hace únicos.

We feel the need to make the things around us our own. Meaningful objects, designs with soul, pieces that reflect our personality or that simply resonate with us. We need to make any space into our own private oasis.

Möwee is more than a brand, it's an attitude. Elegant. Sensual. Alive. Its aim is to create outdoor spaces for feeling at home, giving them an original touch that's fresh and full of personality. In constant innovation, with creativity as a lifestyle. Each collection is a statement of intent. Seducing through the senses and winning hearts with details. Cutting edge design made in house from start to finish. The result is our reason for being, the essence that makes us unique.

TECHNIC MÖWEE



Möwee crea mobiliario para ser vivido. Atemporal, sostenible, funcional y de calidad. Sin perder la elegancia del diseño y arquitectura contemporánea. El mundo outdoor es exigente. Requiere la reinención de recursos para mantener el equilibrio entre tecnología, resistencia y confort. Pero sin duda, nuestro secreto es la innovación, compromiso y pasión común por el trabajo bien hecho.

Möwee creates furniture to be lived. Timeless, sustainable, functional and quality. Without losing the elegance of design and contemporary architecture. The outdoor world is demanding. It requires the reinvention of resources to maintain the balance between technology, strength and comfort. But without a doubt, our secret is innovation, commitment and common passion for a job well done.



Somos sensibles al buen diseño, desde una gestión global y sostenible.



“No es sólo lo que hacemos, sino lo que somos y lo que construimos a nuestro alrededor. Evolucionar y mejorar. Minimizar el impacto en el medioambiente y cuidar nuestro entorno, depende de nosotros mismos. Cuidamos nuestras materias primas, métodos y procesos, porque nuestros productos y la naturaleza, son para toda la vida.”

“It’s not just what we do, but what we are and what we build around us. Evolve and improve. Minimizing the impact on the environment and taking care of our environment depends on ourselves. We take care of our raw materials, methods and processes, because our products and nature, are for life.”



DESIGN MÖWEE

Pura inquietud,
peculiaridad y
pasión.



Héctor Serrano

Pura inquietud, peculiaridad y pasión. Su vocación, el diseño industrial. Para él, la clave del éxito es el equilibrio entre tradición e innovación. Con sus diseños fieles a la sencillez y la belleza, ha conseguido ir un paso más allá y recibir grandes premios como el Red Dot, Interior Design o el New Bus for London. Así como impulsar Borealis, una iniciativa propia dónde realiza el diseño de espacios e instalaciones efímeras.

Pure curiosity, quirkiness and passion. A vocation for industrial design. The key to success is the balance between tradition and innovation. With designs loyal to simplicity and beauty, taking his practice to new levels and winning major awards such as Red Dot, Interior Design and New Bus for London. He also works on Borealis, his own initiative, in which he designs ephemeral spaces and installations.



Un ambigrama con carácter, fresca y singularidad.



Yonoh Studio



Un ambigrama con carácter, fresca y singularidad, que nace del afán de romper esquemas. Formado por Clara del Portillo y Alex Selma, especializados en producto e interiorismo. Amantes de los detalles, cuidan con mimo todos sus diseños, los cuales se caracterizan por su sencillez y funcionalidad. Gracias a su personalidad han sido reconocidos con premios tan prestigiosos como Red Dot o IF Design Award, entre otros.

An ambigram with character, freshness and individuality, arising from the urge to break the mould. Produced by Clara del Portillo and Alex Selma, product and interior design specialists. With an eye for detail, they apply painstaking care to all their designs, characterised by their simplicity and functionality. Their personality has led them to winning some prestigious awards, including Red Dot or IF Design Award.

Equilibrio entre diseño e ingeniería de vanguardia.



Bandada Studio



Bandada Studio es un talentoso equipo multidisciplinar que desarrolla los proyectos más sostenibles e innovadores. Está formado por un equipo de diseñadores e ingenieros, con más de 20 años de experiencia en el sector. Trabajamos para ofrecer calidad y confort en todos nuestros productos.

Bandada Studio is a talented multidisciplinary team that develops the most sustainable and innovative projects. It is formed by a team of designers and engineers, with more than 20 years of experience in the sector. We work to offer quality and comfort in all our products.











RAL 7044



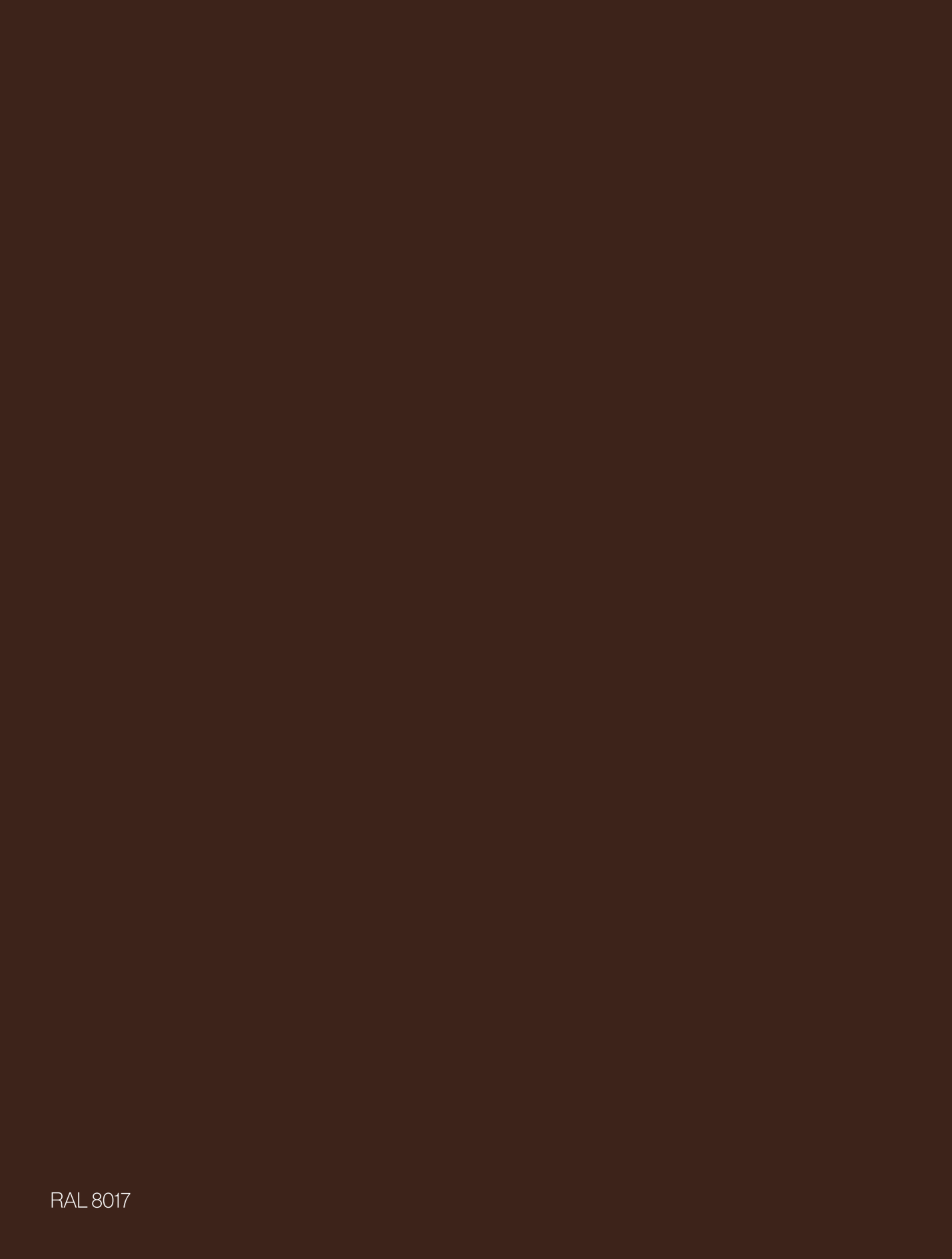

RAL 8017



XALOC	36
CLASSE	58
LACE	72
UNI	100
RIBBONS	112
COVER	120
NATURE	128
BREZ	136
PROJECTS	150
TECHNICALS	186

XALOC

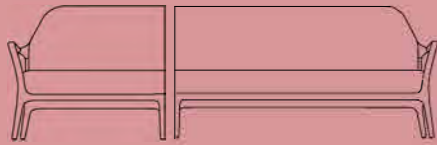
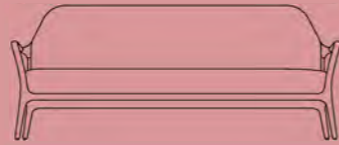

Ese viento tan nuestro, del Mediterráneo. Armónico. Cambiante. Ubicuo. Fresco. Capaz de erosionar y esculpir suaves líneas, como la fundición del aluminio. Dócil. Orgánico. Moldeable. La variedad de tejidos, colores y piezas nos permite llevar la elegancia y calidez de los espacios interiores, al exterior.

That Mediterranean wind, so uniquely ours. Harmonious. Changing. Pervasive. Fresh. Able to erode and sculpt smooth lines, like forging aluminium. Docile. Organic. Malleable. The variety of fabrics, colours and pieces allows us to take the elegance and warmth of indoor spaces outside.



Xaloc by Héctor Serrano



Möwee Outdoor **Xaloc**



Xaloc by Héctor Serrano



Xaloc by Héctor Serrano



Möwee Outdoor **Xaloc**



Xaloc by Héctor Serrano



Xaloc by Héctor Serrano



Möwee Outdoor **Xaloc**



Xaloc by Héctor Serrano





Xaloc by Héctor Serrano



Möwee Outdoor **Xaloc**



Xaloc by Héctor Serrano



Möwee Outdoor **Xaloc**



Xaloc by Héctor Serrano

CLASSE

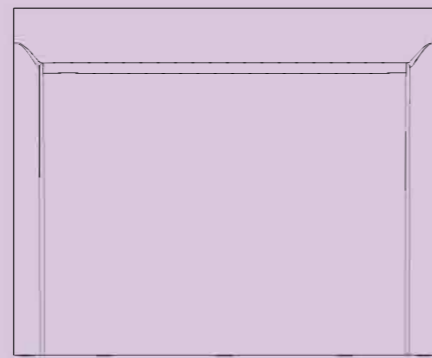
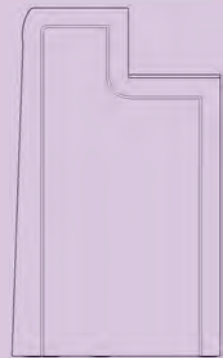
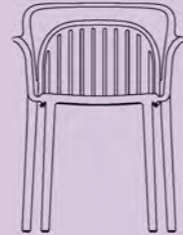
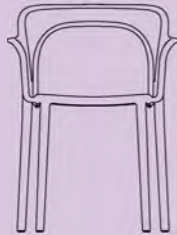
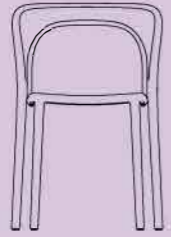

Una combinación de estilos clásicos y contemporáneos. Sus curvas. Su estructura. Una colección singular, orgánica, ergonómica y con personalidad. Sillas de una sola pieza, apilables, realizadas en polipropileno, y barras de bar, realizadas en polietileno, todo ello diseñado para vivir al aire libre.

A blend of classic and contemporary styles. Their curves. Their structure. A unique, organic, ergonomic collection with personality. Single piece stackable, made with polypropylene and polyethylene, chairs and bars top designed for life in the open air.





Möwee Outdoor **Classe**

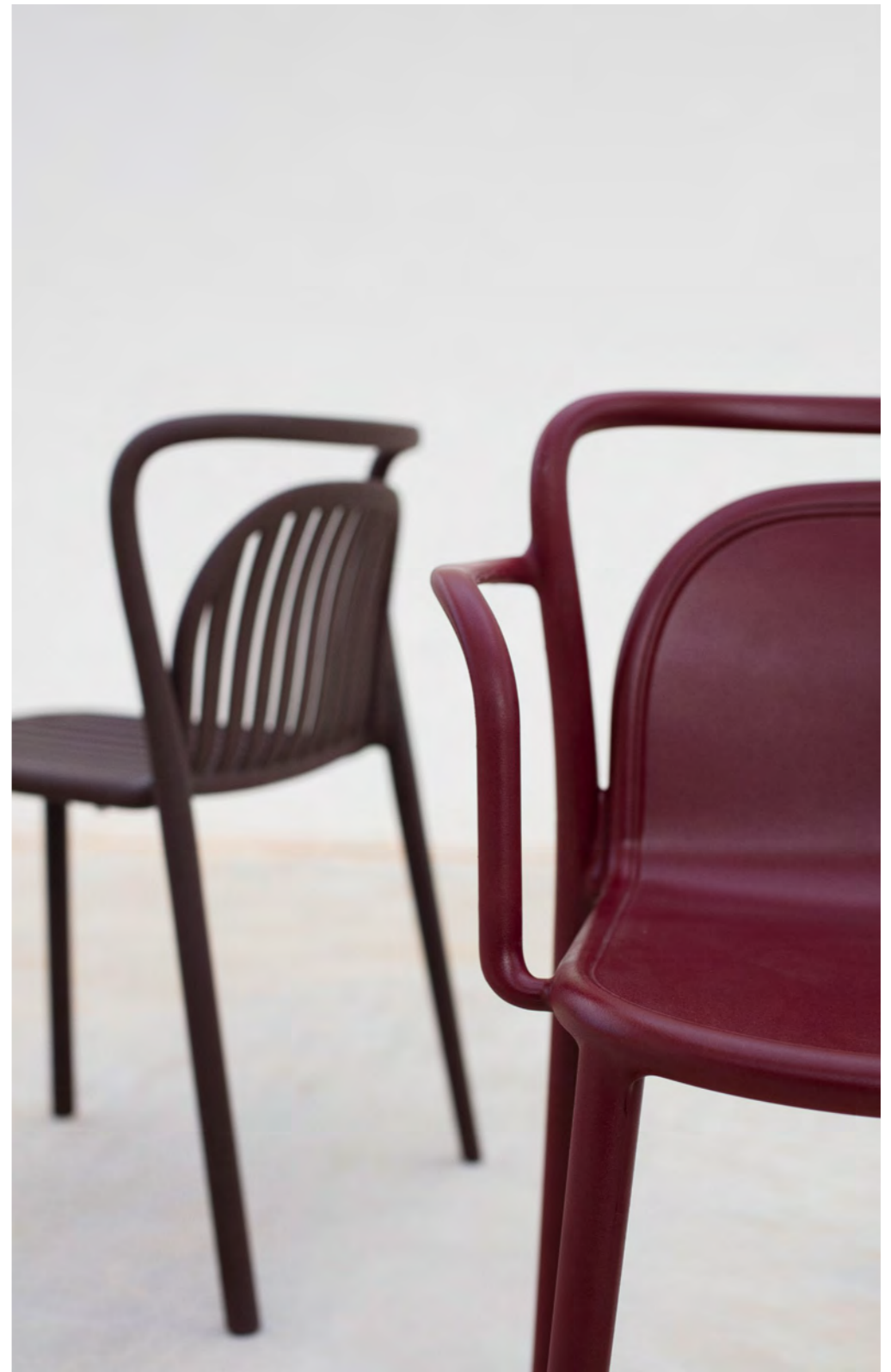



Möwee Outdoor **Classe**







Classe by Yonoh Studio



Classe by Yonoh Studio

LACE

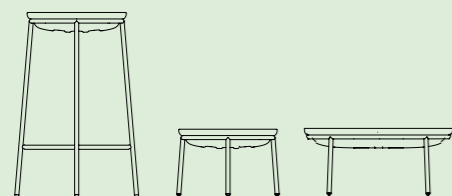
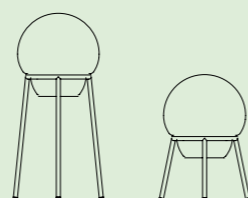
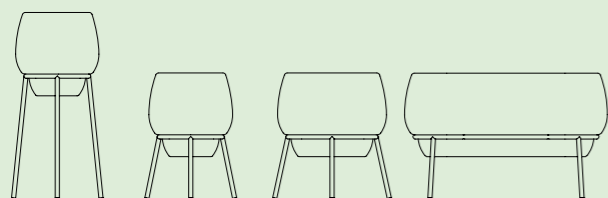
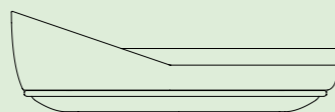
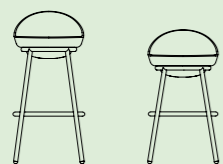
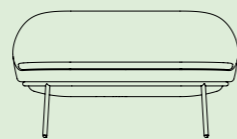

Calma, comodidad y ligereza. Sus volúmenes y cantos redondeados conseguidos por rotomoldeo, hacen de ella una colección amable y atractiva. Una combinación perfecta de materiales. Textil, que aporta confort y diseño, junto al metal, que reduce la cantidad de polietileno y equilibra el peso visual de sus piezas.

Calm, comfort and lightness. The volumes and rounded edges are achieved by rotational moulding, making this collection both friendly and attractive. A perfect blend of materials. Textiles provide comfort and design alongside the metal, reducing the amount of polyethylene used and balancing the visual impact of the pieces.



Möwee Outdoor **Lace**



Lace by Yonoh Studio



Möwee Outdoor **Lace**



Lace by Yonoh Studio



Lace by Yonoh Studio



Möwee Outdoor **Lace**



Lace by Yonoh Studio





Möwee Outdoor **Lace**



Lace by Yonoh Studio



Möwee Outdoor **Lace**



Lace by Yonoh Studio





Möwee Outdoor **Lace**

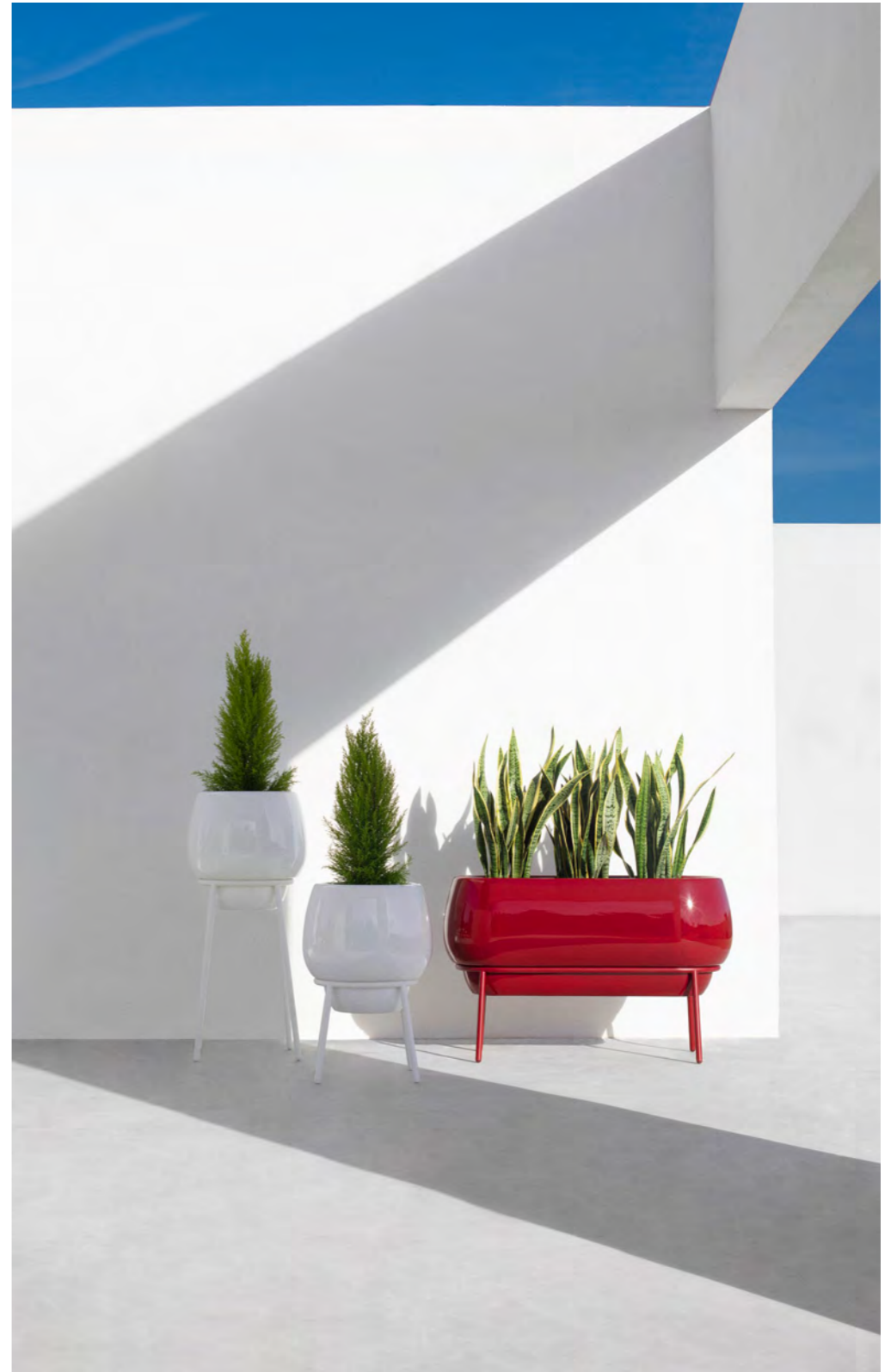

Lace by Yonoh Studio



Lace by Yonoh Studio



Möwee Outdoor **Lace**



Lace by Yonoh Studio



Möwee Outdoor **Lace**



Lace by Yonoh Studio



Lace by Yonoh Studio

UNI

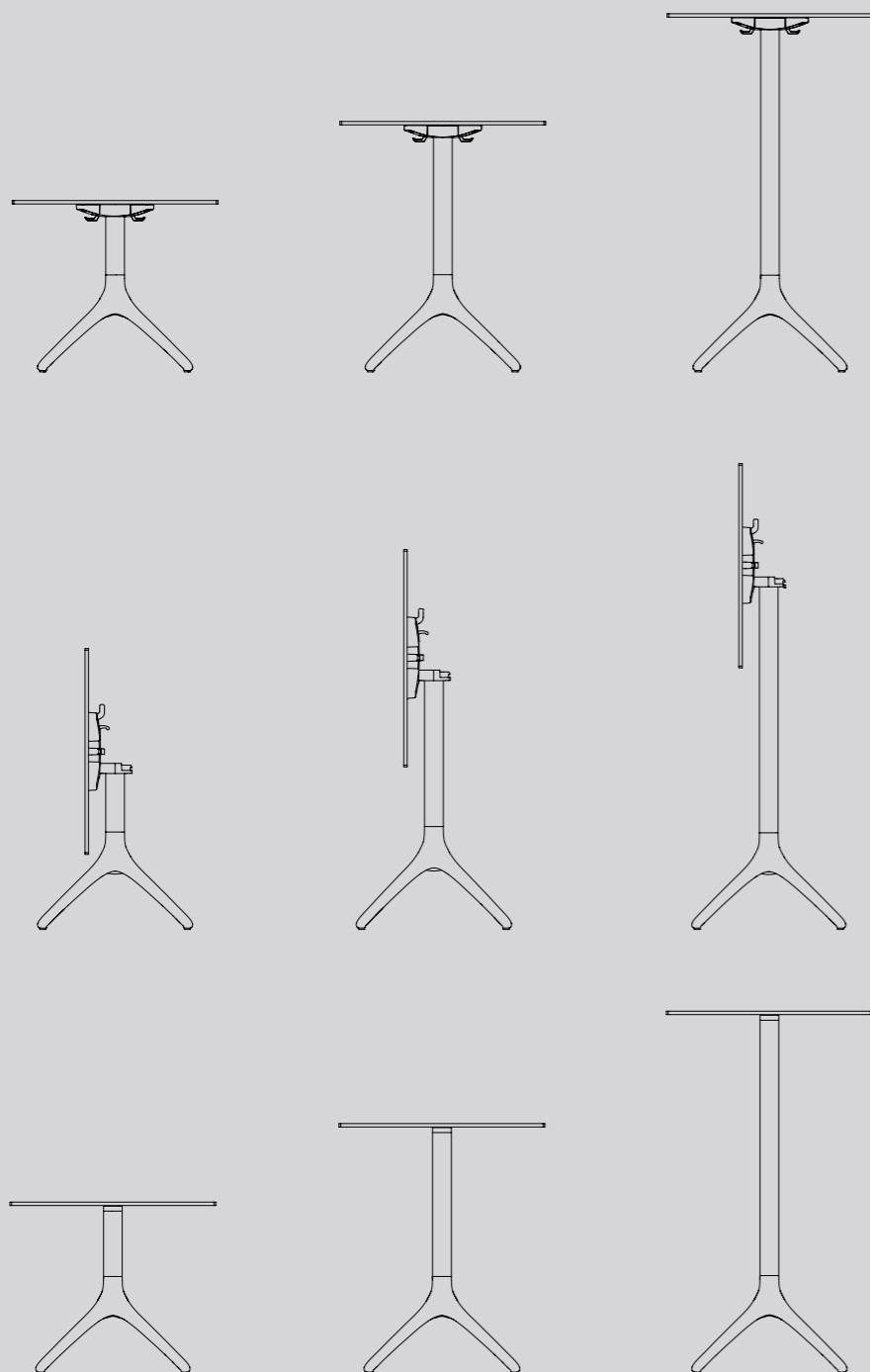

Su razón de ser es la versatilidad. Mesas sencillas con estructura de aluminio de colores, materiales y formas diferentes. Un sinfín de posibilidades para todos los gustos. Calidad y durabilidad. Elegancia y delicadeza.

Versatility is their hallmark style. Simple tables with aluminium structure in different colours, materials and forms. Endless possibilities for all tastes. Quality and durability. Elegance and finesse.



Möwee Outdoor **Uni**



102 103



Möwee Outdoor **Uni**



104 105





Möwee Outdoor **Uni**



108 109



Möwee Outdoor **Uni**



RIBBONS

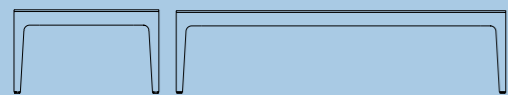
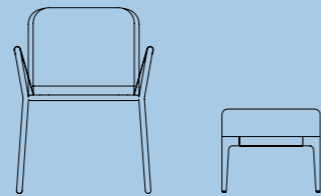
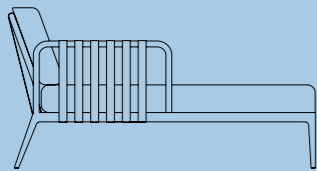
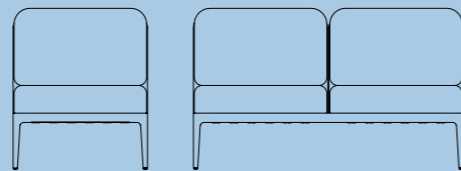
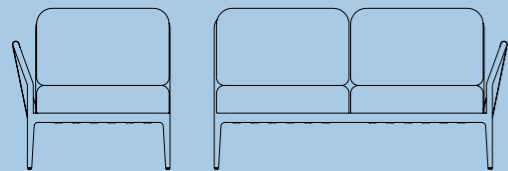
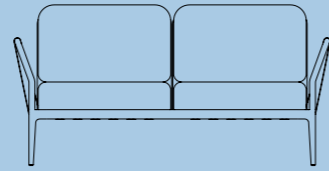
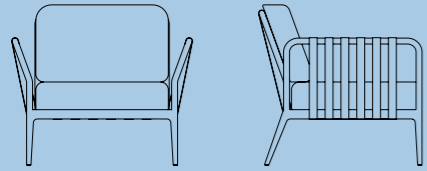

**Una colección inconfundible por su belleza y robustez.
Homenaje a la tradición manufacturera valenciana como reto a la
innovación, haciéndola sostenible y duradera.
Una colección con detalles que la hacen única.
Descubrimos su lado más representativo, Ribbons. Ingeniería y
tradicón se unen, consiguiendo así una colección con carácter propio.**

An unmistakable collection for its beauty and robustness.
A tribute to the Valencian manufacturing tradition as a challenge to
innovation, making it sustainable and durable.
A collection with details that make it unique.
We discover its most representative side, Ribbons. Engineering and
tradition come together, thus achieving a collection with its own character.



Ribbons by Bandada Studio





Möwee Outdoor **Ribbons**



COVER

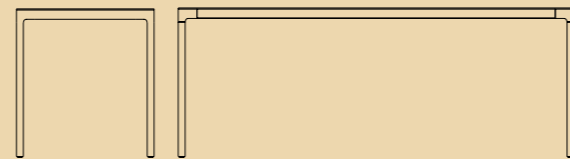
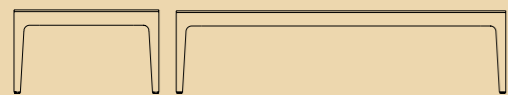
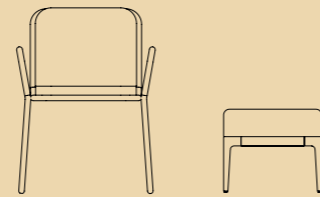
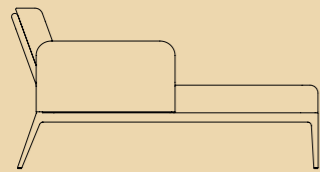
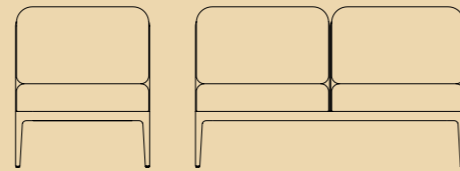
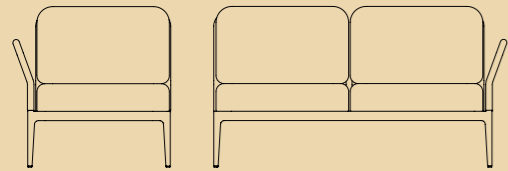
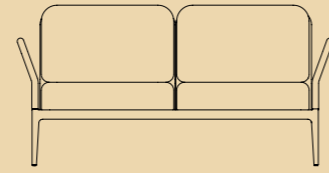
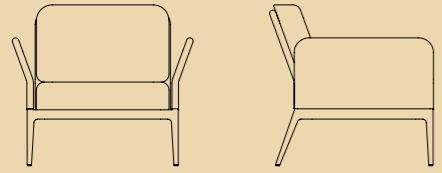

Una colección inconfundible por su belleza y robustez. Homenaje a la tradición manufacturera valenciana como reto a la innovación, haciéndola sostenible y duradera. Elegancia. Sencillez. Comodidad. Una colección única, diferente, distinguida, con carácter. Un sinfín de colores para todos los gustos y espacios.

An unmistakable collection for its beauty and robustness. A tribute to the Valencian manufacturing tradition as a challenge to innovation, making it sustainable and durable. Elegance. Simplicity. Comfort. A unique collection, different, distinguished, with character. An endless number of colors for all tastes and spaces.



Möwee Outdoor **Cover**





Möwee Outdoor **Cover**



Cover by Bandada Studio



Cover by Bandada Studio

NATURE

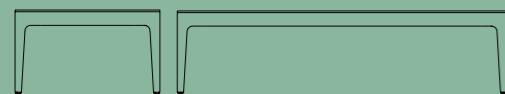
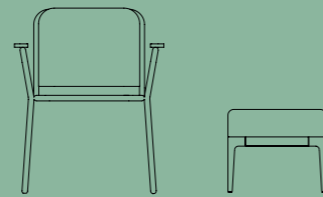
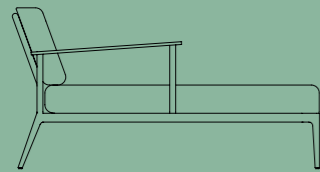
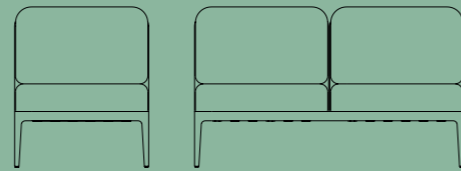
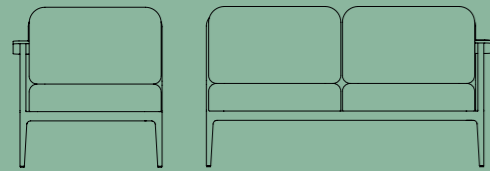
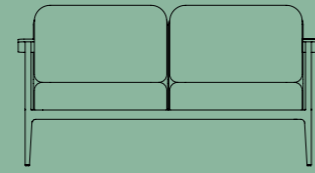
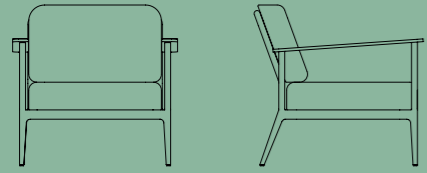

Una colección inconfundible por su belleza y robustez. Homenaje a la tradición manufacturera valenciana como reto a la innovación, haciéndola sostenible y duradera. Una versión más fresca, Nature. Presenta toques de madera natural y sostenible, que otorga calidez y comodidad, y hace de ella una colección única.

An unmistakable collection for its beauty and robustness. A tribute to the Valencian manufacturing tradition as a challenge to innovation, making it sustainable and durable. A fresher version, Nature. It presents touches of natural and sustainable wood, which gives warmth and comfort, and makes it a unique collection.



Nature by Bandada Studio





Nature by Bandada Studio

BREZ

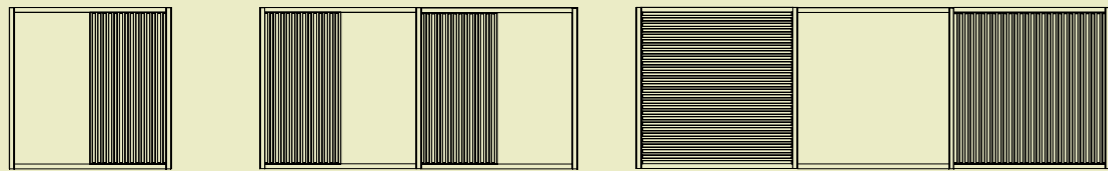
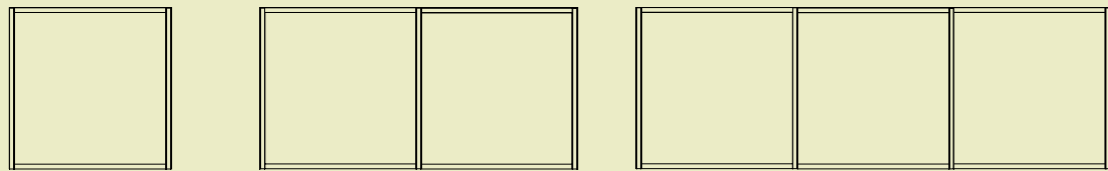
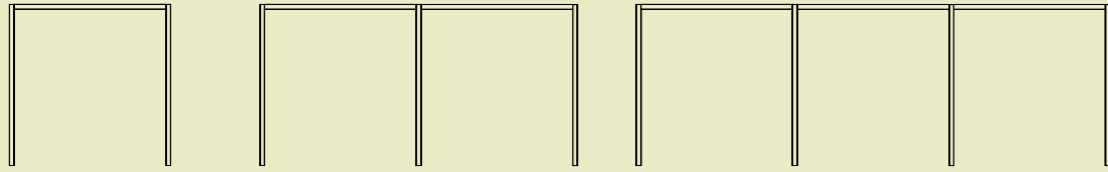

**Equilibrio entre diseño y arquitectura de vanguardia.
Espacios de autor. La posibilidad de hacer tuyo cualquier
entorno, gracias a nuestras estructuras modulares con
diferentes acabados, colores, dimensiones, iluminación y
otros complementos.**

Balance between cutting edge design and architecture.
Signature spaces. The chance to put your own stamp on any
space, using our modular structures in a range of finishes,
colours dimensions, illumination and accessories.



Brez by Bandada



Möwee Outdoor **Brez**



Brez by Bandada



Brez by Bandada



Möwee Outdoor **Brez**



144 145



Brez by Bandada



Brez by Bandada

PROJECTS/
CONTRACT



Xaloc by Héctor Serrano



Xaloc by Héctor Serrano
Classe by Yonoh Studio



Xaloc by Héctor Serrano



Xaloc by Héctor Serrano



Lace by Yonoh Studio







Classe by Yonoh Studio
Uni by Héctor Serrano



Classe by Yonoh Studio
Uni by Héctor Serrano





Classe by Yonoh Studio
Uni by Héctor Serrano



Lace by Yonoh Studio
Uni by Héctor Serrano



Classe by Yonoh Studio
Uni by Héctor Serrano



Classe by Yonoh Studio
Uni by Héctor Serrano



Brez by Bandada
Xaloc by Héctor Serrano



Brez by Bandada
Xaloc by Héctor Serrano



Cover by Bandada

TECHNICALS

XALOC

Héctor Serrano

Butaca Armchair

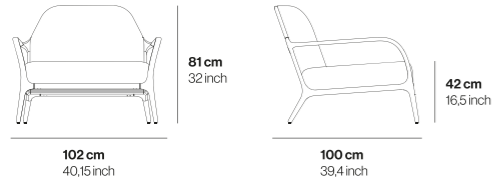

Sofá Sofa

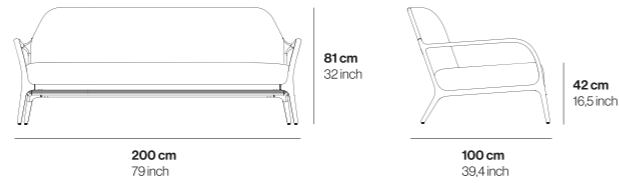

Chaise Longue Chaise Longue

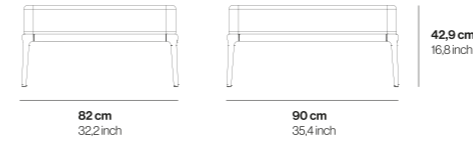

Tumbona Sunchair

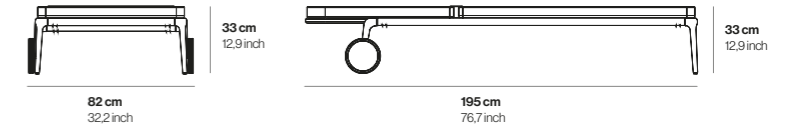

Derecho 90 90 Right

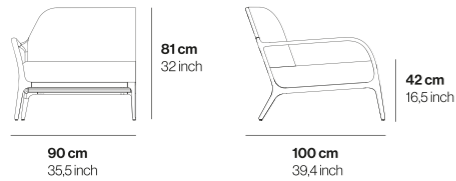

Derecho 160 160 Right

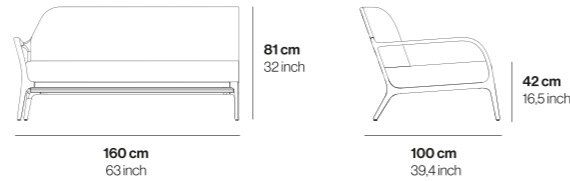

Puff 50 50 Puff

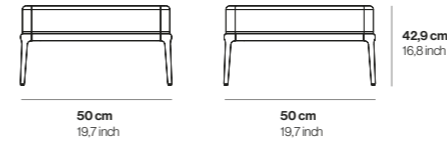

Mesa 120 120 Table

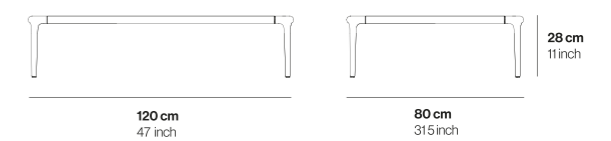

Central 90 90 Central

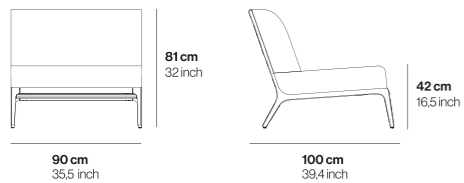

Central 160 160 Central

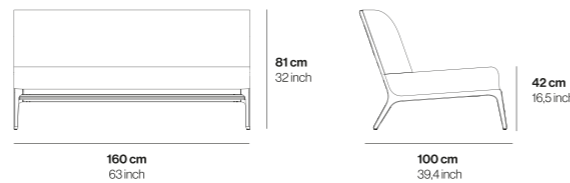

Mesa 80 80 Table

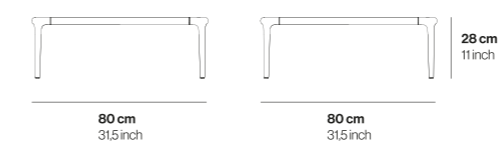

Mesa 50 50 Table

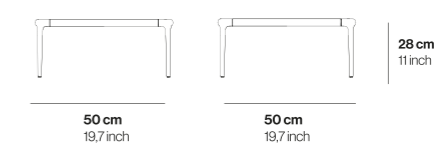

Izquierdo 90 90 Left

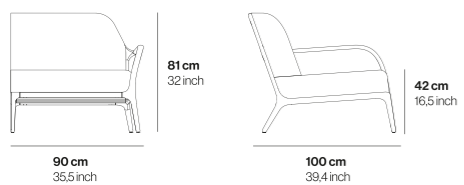

Izquierdo 160 160 Left

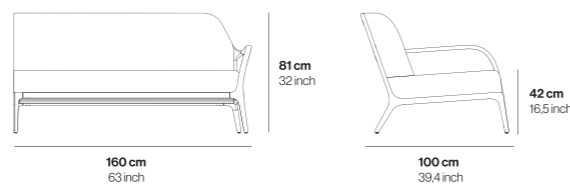

Mesa 200 200 Table

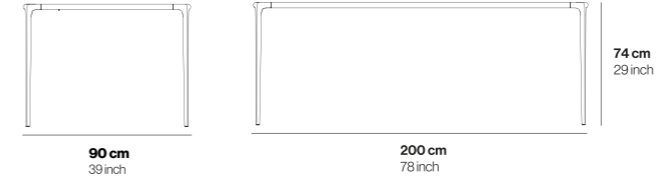

Mesa 160 160 Table

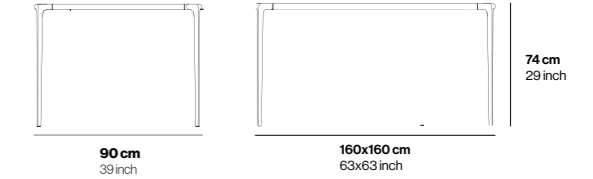

XALOC

Héctor Serrano

Mesa 140 140 Table

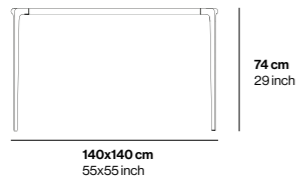

Mesa 90 90 Table

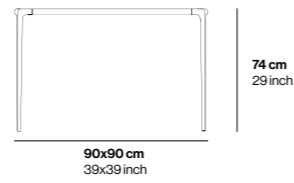

Mesa 70 70 Table

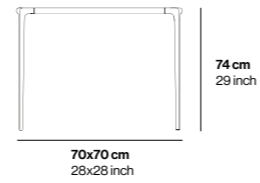

Maceta 45x45 45x45 Pot

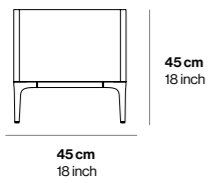

Jardinera Planter

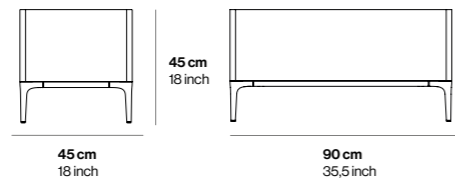

Maceta 45x90 45x90 Pot

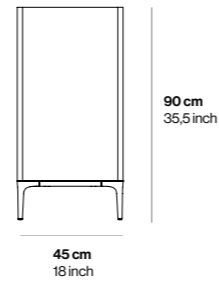

Acabados Finishes

Estructura Frame

Aluminio lacado Lacquered Aluminum

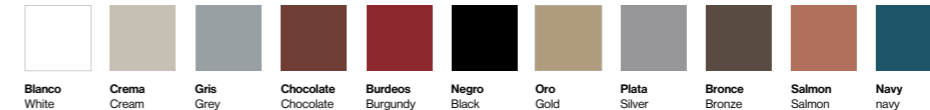

Textil Fabrics

Molder



Acua



Agora Panama



Agora Liso



Dolce



Tableros Tabletop

Neolith Neolith

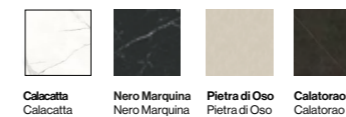

HPL 10 mm HPL 10 mm

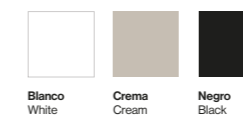

Vidrio templado tintado Tinted Tempered Glass



XALOC

Héctor Serrano
OPTIONAL COMBINATIONS

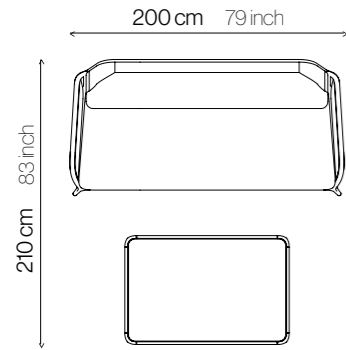

Xaloc 1

1 x Sofá
1 x Mesa 120 / 120 Table

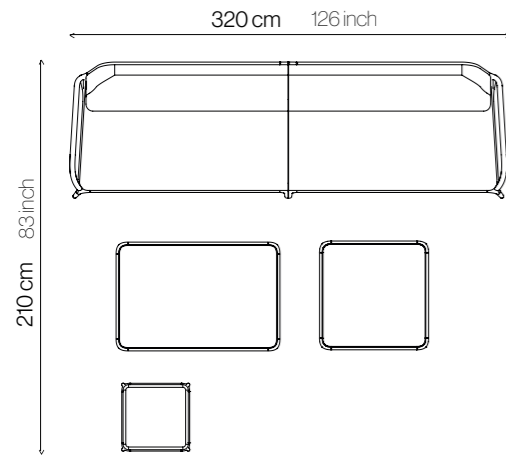

Xaloc 2

1 x Izquierdo 160 / 160 Left
1 x Derecho 160 / 160 Right
1 x Mesa 120 / 120 Table
1 x Mesa 80 / 80 Table
1 x Puff 50 / 50 Puff

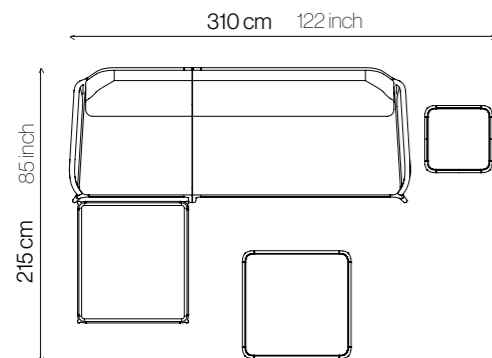

Xaloc 3

1 x Izquierdo 160 / 160 Left
1 x Derecho 90 / 90 Right
1 x Chaise Longue
1 x Mesa 80 / 80 Table
1 x Mesa 50 / 50 Table

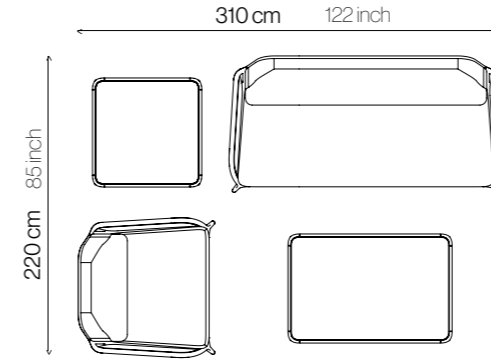

Xaloc 4

1 x Sofá
1 x Butaca / Armchair
1 x Mesa 120 / 120 Table
1 x Mesa 80 / 80 Table

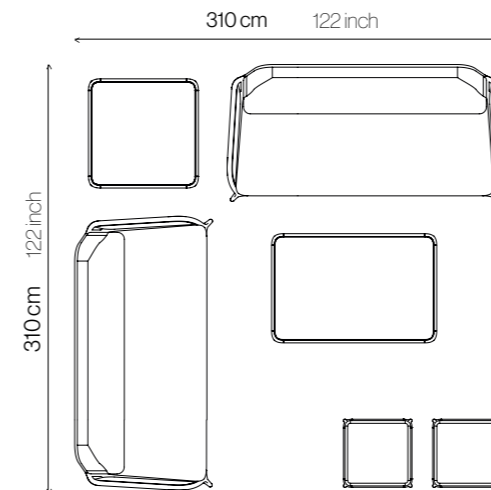

Xaloc 5

2 x Sofá
1 x Mesa 120 / 120 Table
1 x Mesa 80 / 80 Table
2 x Puff 50 / 50 Puff

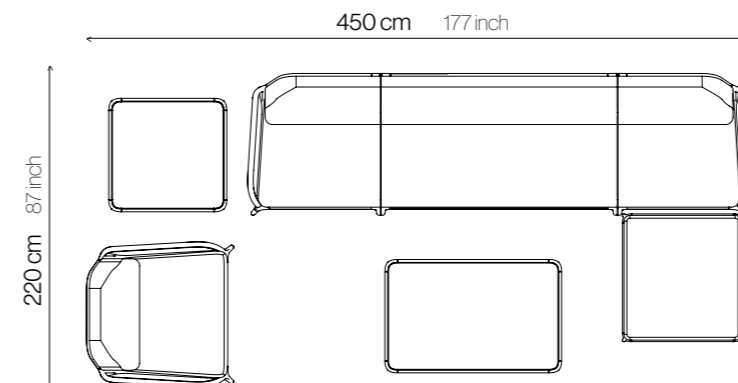

Xaloc 6

1 x Derecho 90 / 90 Right
1 x Izquierdo 90 / 90 Left
1 x Central 160 / 160 Central
1 x Chaise Longue
1 x Mesa 120 / 120 Table
1 x Mesa 80 / 80 Table

CLASSE

Yonoh Studio

Silla Classe Classe Chair

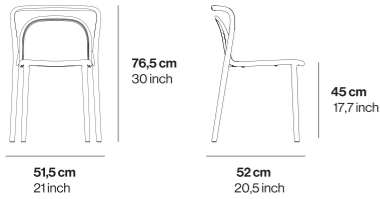

Sillón Classe Classe Armchair

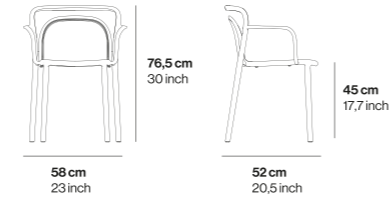

Silla Classe Slats Slats Classe Chair

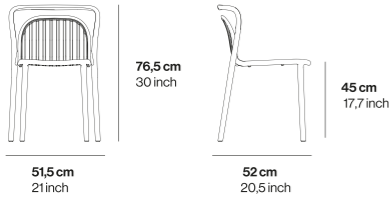

Sillón Classe Slats Slats Classe Armchair

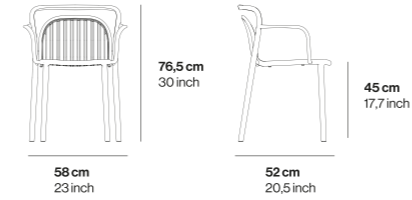

Acabados Finishes



Bar Classe recto Straight Classe Bar

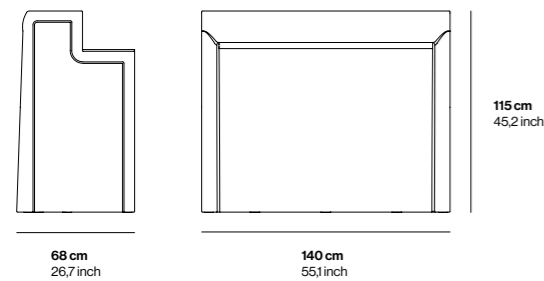

Bar Classe curvo Curved Classe Bar

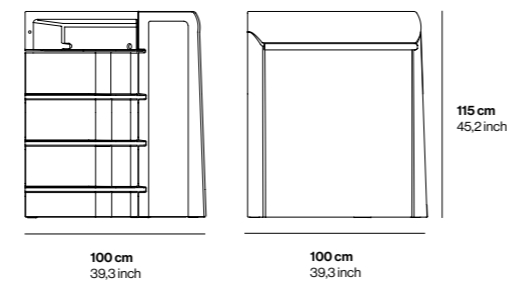

Acabados Finishes

Básico Basic / **Lacado** Lacquered / **Iluminación perfil LED** Profile LED Lighting



Retroiluminado Backlit

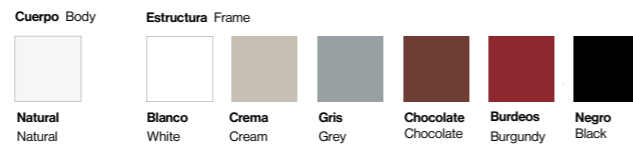

LACE

Yonoh Studio

Butaca Lounge chair

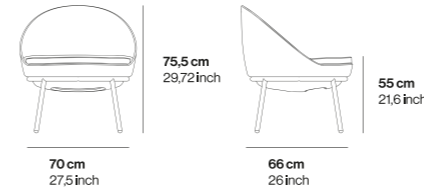

Sofá Sofa

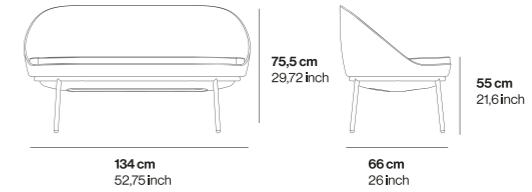

Mesa 60 Low 60 Low Table

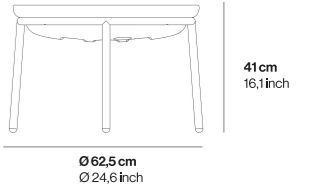

Mesa 60 x 90 Low 60 x 90 Low Table

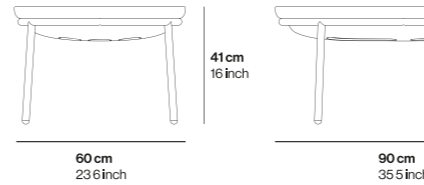

Taburete 90 90 Stool

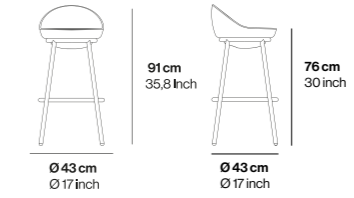

Taburete 80 80 Stool

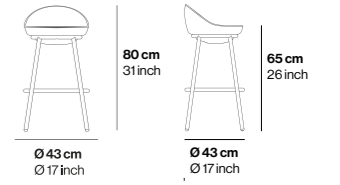

Maceta 50 High 50 High Pot

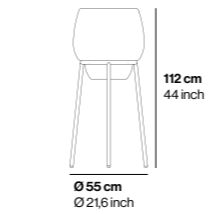

Maceta 50 Low 50 Low Pot

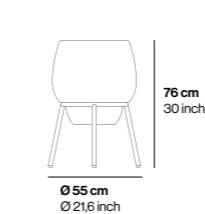

Maceta 65 65 Pot

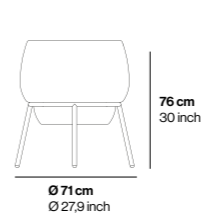

Jardinera 50x120 50x120 Planter

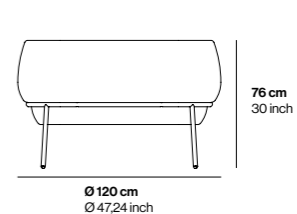

Mesa 60 High 60 High Table

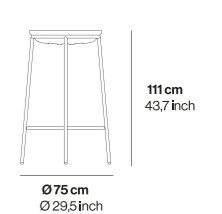

Lámpara 50 High 50 High Lamp



Lámpara 50 Low 50 Low lamp

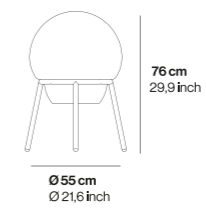

Daybed Daybed

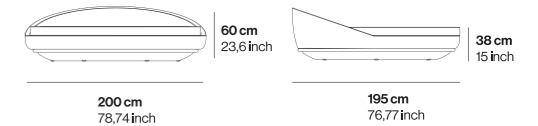

LACE

Yonoh Studio

Bar Lace Recto Straight Lace Bar

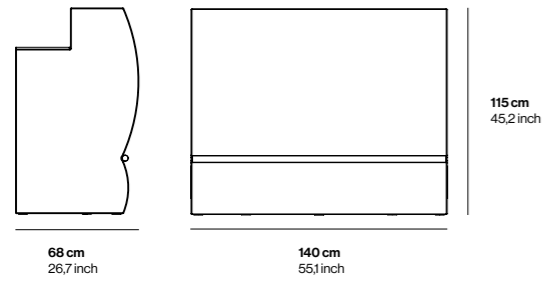

Bar Lace Curvo Curved Lace Bar

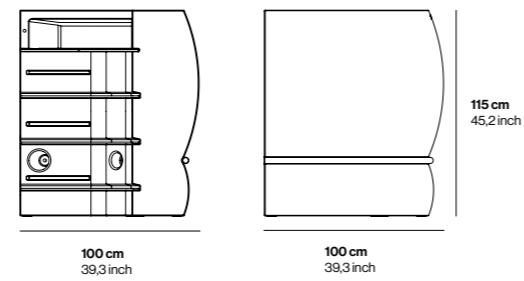

Acabados Finishes

Retroiluminado Backlit

Cuerpo Body



Natural

Estructura Frame



Blanco White



Crema Cream



Gris Grey



Chocolate Chocolate



Burdeos Burgundy



Negro Black



Maceta 50 High
High 50 Pot



Maceta 50
50 Pot



Maceta 65
65 Pot

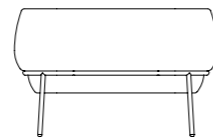

Lámpara High
High Lamp



Lámpara Low
Low Lamp

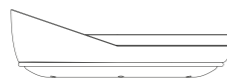

Daybed

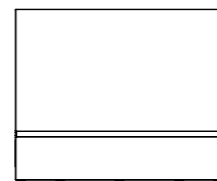

Bar Lace Recto
Straight Bar Lace

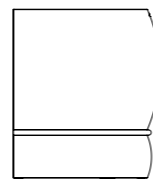

Bar Lace Curvo
Curved Bar Lace

Iluminación perfil Led Profile Led Lighting

Colores Colors



Blanco White



Crema Cream



Gris Grey



Chocolate Chocolate



Burdeos Burgundy



Negro Black



Daybed
Daybed

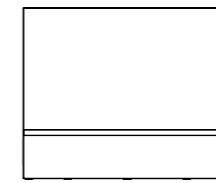

Bar Lace Recto
Straight Bar Lace



Bar Lace Curvo
Curved Bar Lace

Acabados Finishes

Colores Colors

Básico Basic / Lacado Lacquered



Blanco White



Crema Cream



Gris Grey



Chocolate Chocolate



Burdeos Burgundy



Negro Black

Textil Acolchado Stuffing Fabrics

Acua



Blanco 00
00 White



Arena 07
07 Sand



Pizarra 72
72 Slate



Chocolate 20
20 Chocolate



Granate 25
25 Burgundy



Negro 90
90 Black

Agora Liso



Blanco 3701
3701 White



Perla 3735
3735 Pearl



Mineral 3729
3729 Mineral



Café 3713
3713 Coffee



Granate 3711
3711 Burgundy



Negro 3732
3732 Black

Textil Acolchado Stuffing Fabrics

Agora Panama



Blanco 3739
3739 White



Fossil 3659
3659 Fossil



Cloud 3658
3658 Cloud



Coco 8001
8001 Coco



Garnet 8012
8012 Garnet



Onyx 3657
3657 Onyx

Molder



Blanco 300
300 White



Luna 301
301 Moon



Gris 370
370 Grey



Marrón 323
323 Brown



Morgon 325
325 Morgon



Negro 390
390 Black

UNI

Héctor Serrano

Abatible 50 50 Folding

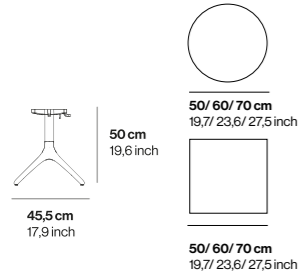

Abatible 73 73 Folding

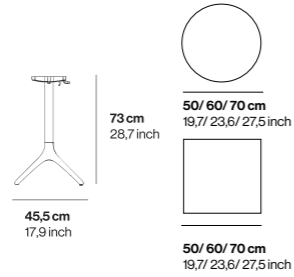

Abatible 105 105 Folding

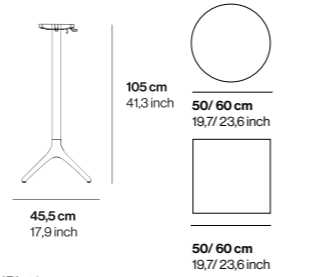

Fijo 50 50 Fixed

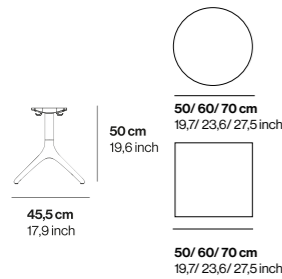

Fijo 73 73 Fixed

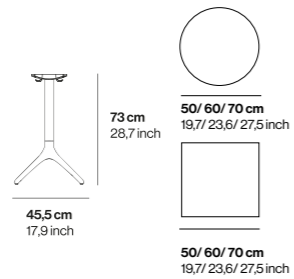

Fijo 105 105 Fixed

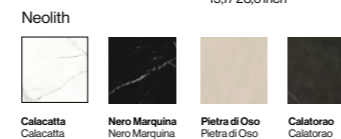
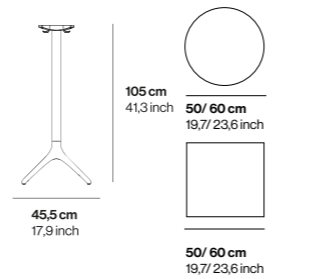

Fijo para vidrio 50 50 Glass Fixed

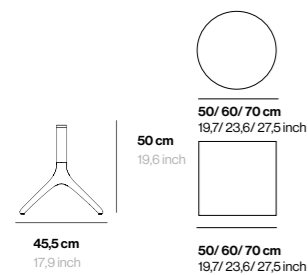

Fijo para vidrio 73 73 Glass Fixed

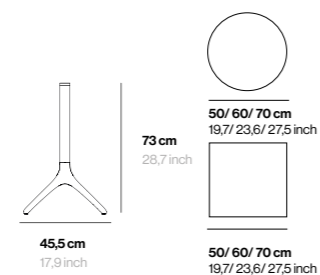

Fijo para vidrio 105 105 Glass Fixed

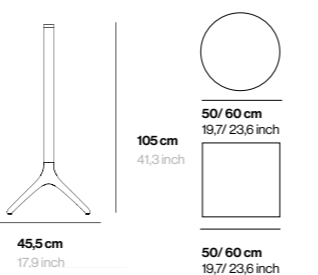

UNI XL

Héctor Serrano

Fijo 50 XL 50 Fixed XL

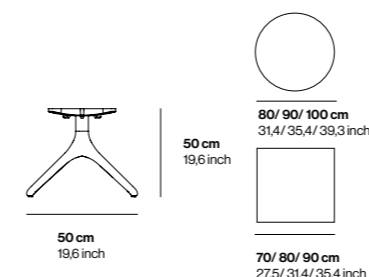

Fijo 73 XL 73 Fixed XL

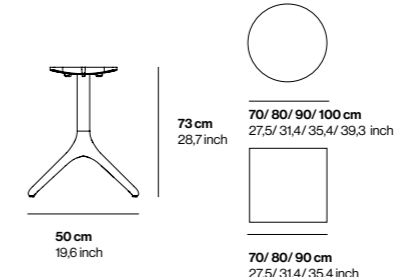

Fijo 105 XL 105 Fixed XL

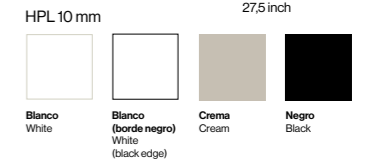
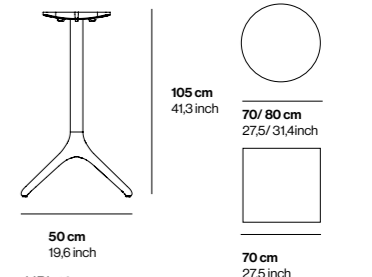

Fijo cerámico 50 XL 50 Ceramic Fixed XL

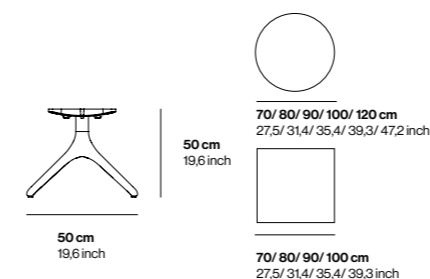

Fijo cerámico 73 XL 73 Ceramic Fixed XL

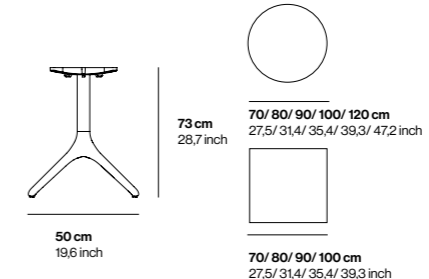

Fijo cerámico 105 XL 105 Ceramic Fixed XL

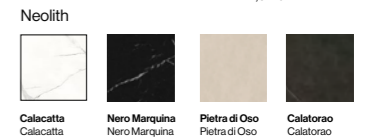
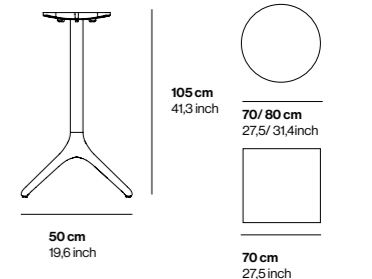

Fijo vidrio 50 XL 50 Glass Fixed XL

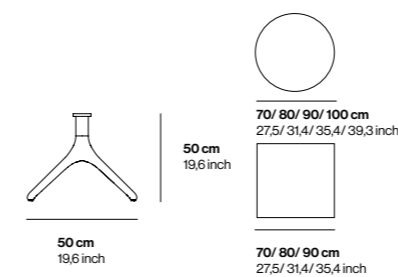

Fijo vidrio 73 XL 73 Glass Fixed XL

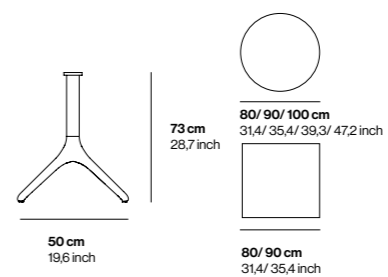

Fijo vidrio 105 XL 105 Glass Fixed XL

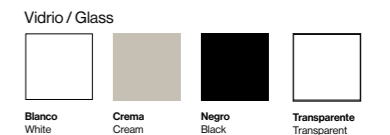
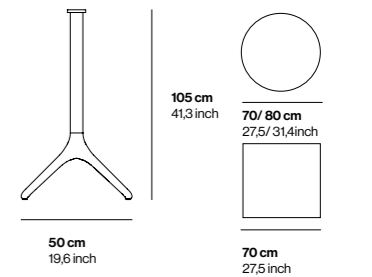

RIBBONS

Bandada Studio

Butaca Longue chair

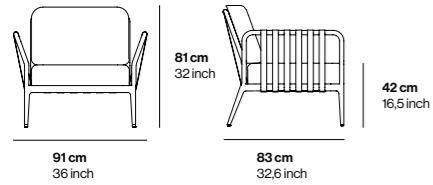

Derecho Right

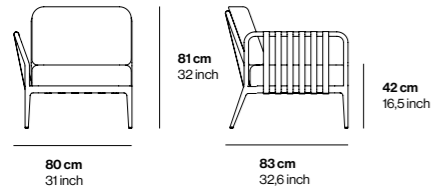

Central Central

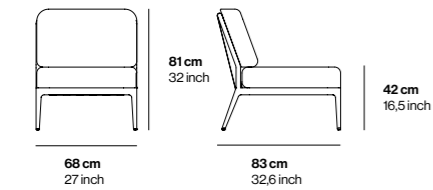

Izquierdo Left

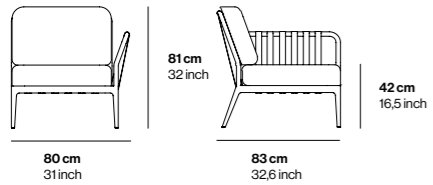

Chaiselongue derecho Right chaiselongue

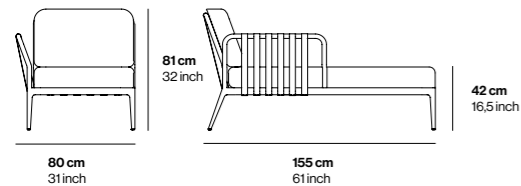

Sofá Sofa

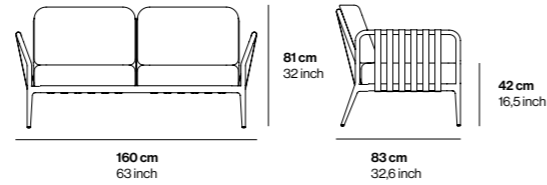

Derecho doble Double right

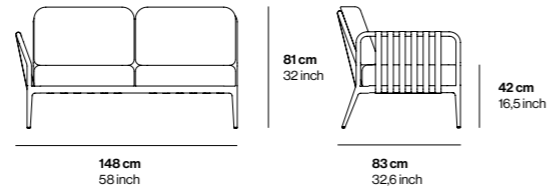

Central doble Double central

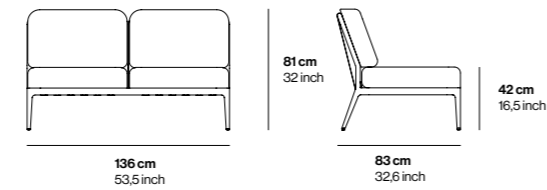

Izquierdo doble Double left

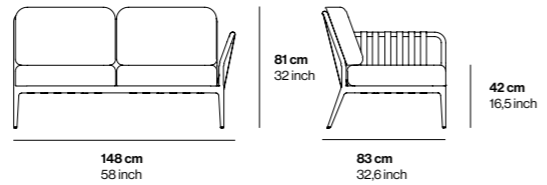

Chaiselongue izquierdo Left chaiselongue

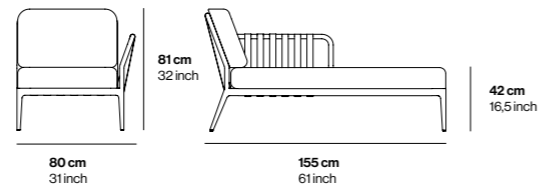

Divano Divan

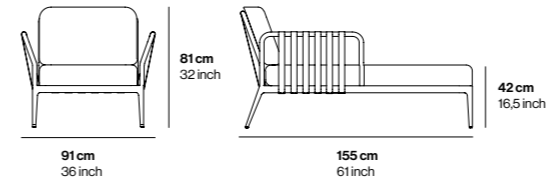

Sillón Armchair

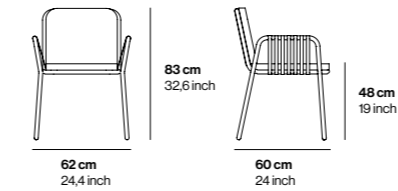

Mesa 50 50 Table

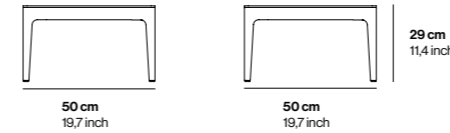

Mesa 76 76 Table

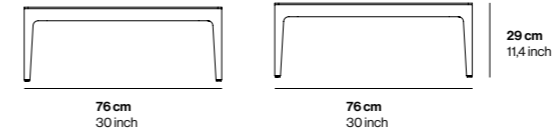

Mesa 90 90 Table

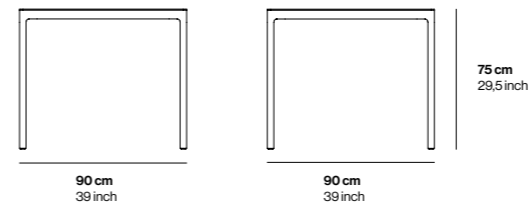

Esquinero Corner

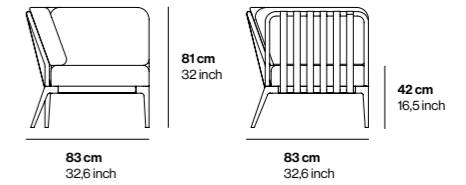

Puff Puff

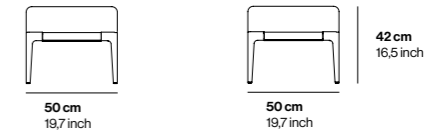

Mesa 115 115 Table

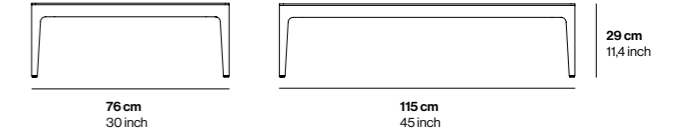

Mesa 70 70 Table

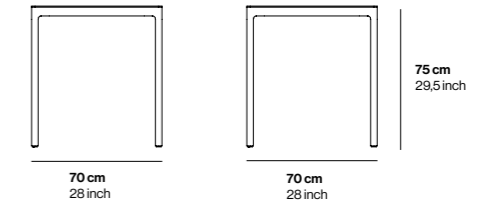

Mesa 138 138 Table

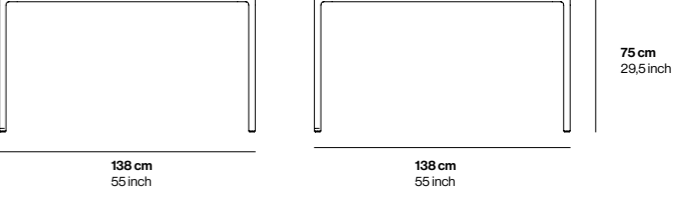

RIBBONS

Mesa 160 160 Table

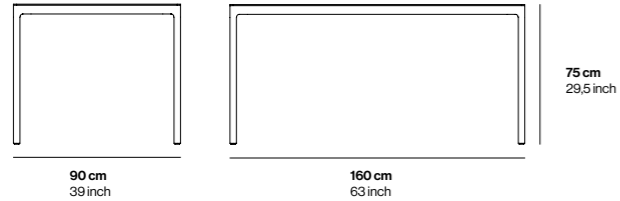

Mesa 200 200 Table

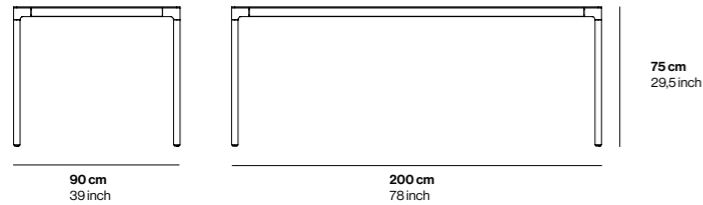

Mesa 250 250 Table

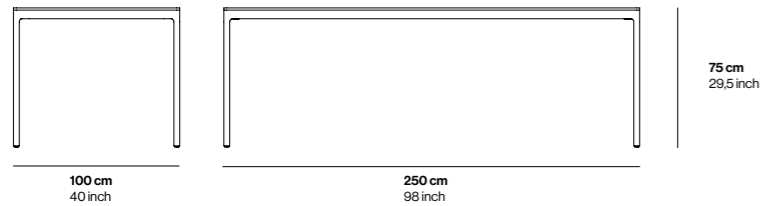

Mesa 300 300 Table



Acabados Finishes

Estructura Frame

Aluminio lacado Lacquered Aluminum

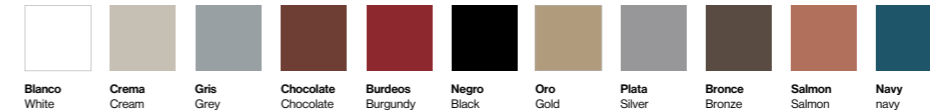

Textil Fabrics

Molder



Agora Panama



Agora Liso



Dolce



Tableros Tabletop

Neolith Neolith

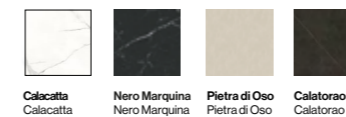

HPL 10 mm HPL 10 mm

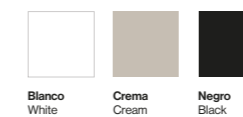

Vidrio templado tintado Tinted Tempered Glass



Cintas Ribbons

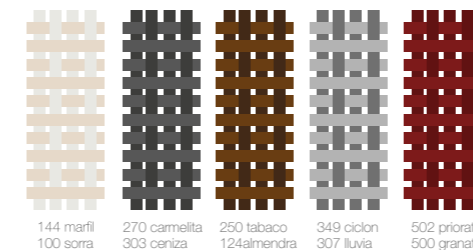

COVER

Bandada Studio

Butaca Longue chair

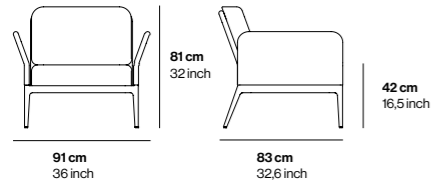

Derecho Right

Sofá Sofa

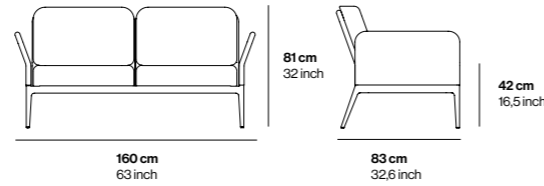

Derecho doble Double right

Divano Divan

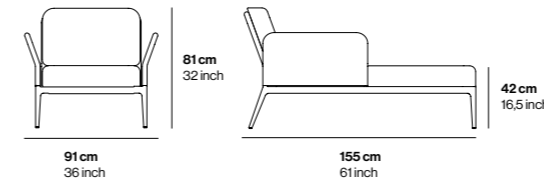

Sillón Armchair

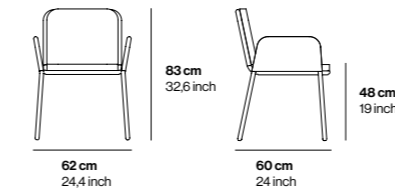

Esquinero Corner

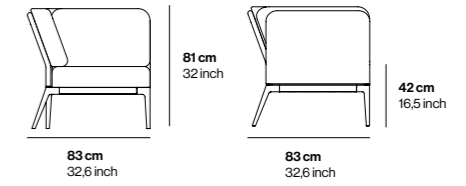

Central Central

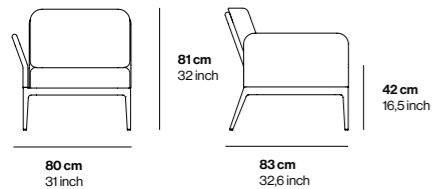

Central doble Double central

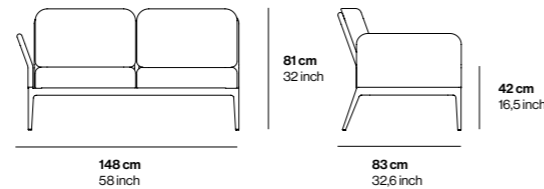

Izquierdo Left

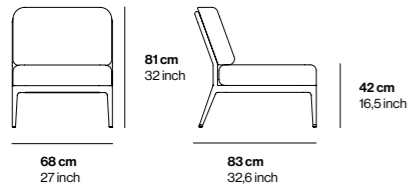

Izquierdo doble Double left

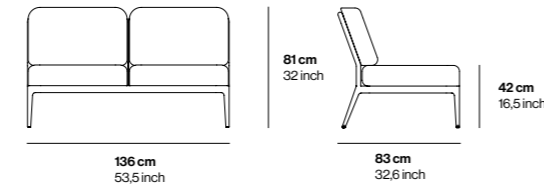

Chaiselongue derecho Right chaiselongue

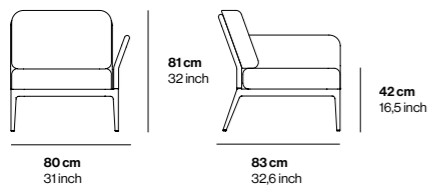

Chaiselongue izquierdo Left chaiselongue

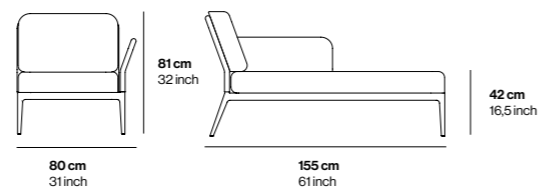
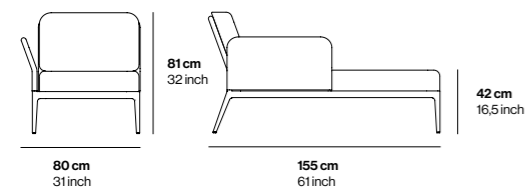
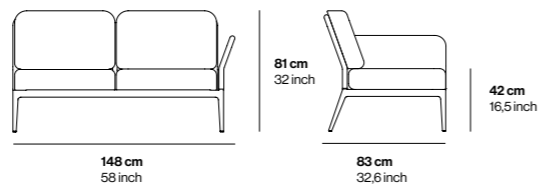

Acabados Finishes

Estructura Frame

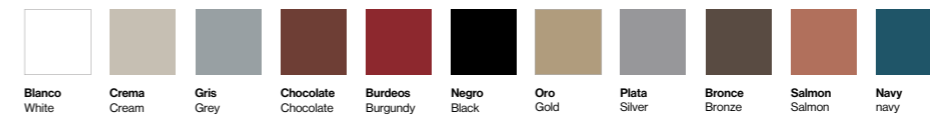

Textil Fabrics

Molder



Agora Panama



Dolce



Agora Liso



NATURE

Bandada Studio

Butaca Longue chair

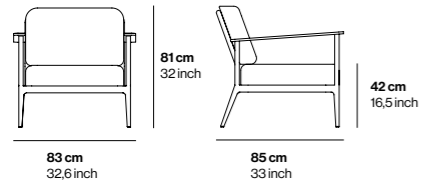

Derecho Right

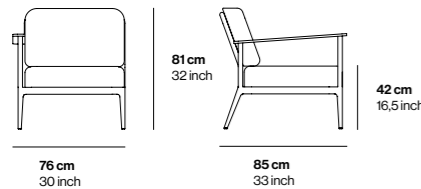

Central Central

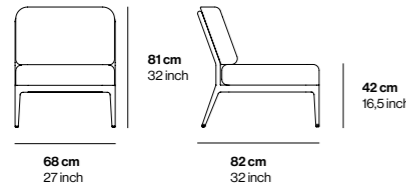

Izquierdo Left

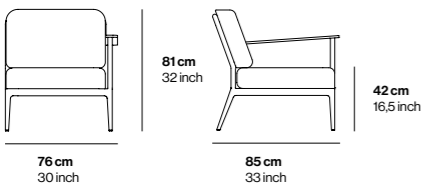

Chaiselongue derecho Right chaiselongue

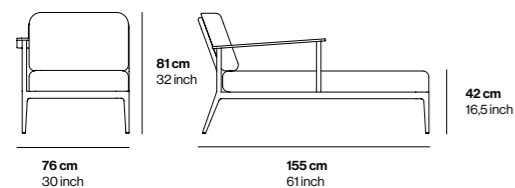

Sofá Sofa

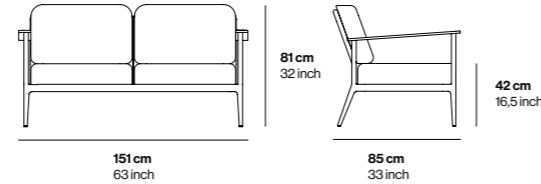

Derecho doble Double right

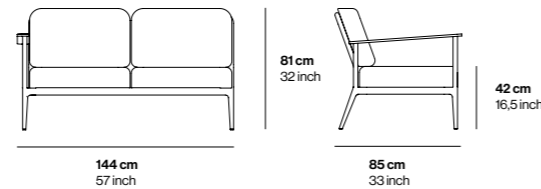

Central doble Double central

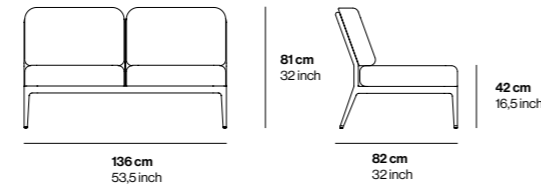

Izquierdo doble Double left

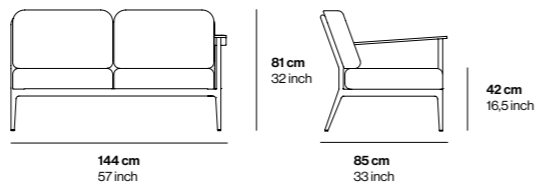

Chaiselongue izquierdo Left chaiselongue

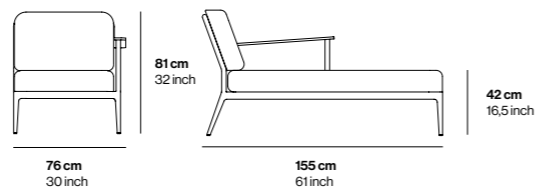

Divano Divan

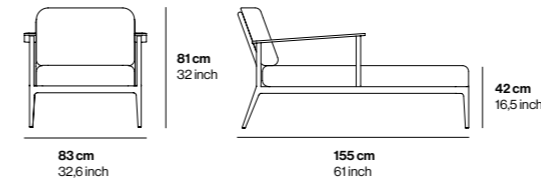

Sillón Armchair

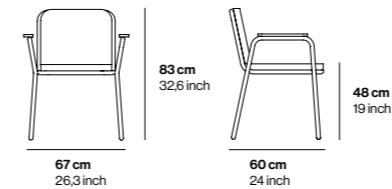

Esquinero Corner

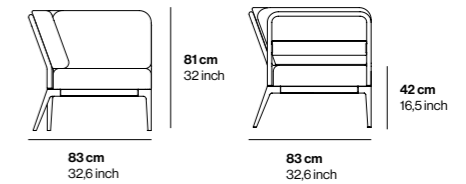

Acabados Finishes

Estructura Frame



Reposabrazos Armrest

Textil Fabrics

Molder



Dolce



Agora Panama

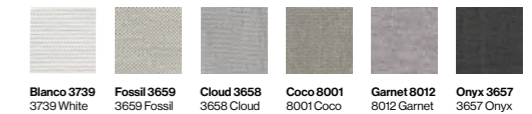

Agora Liso



BREZ

Bandada Studio

BREZ SIMPLE

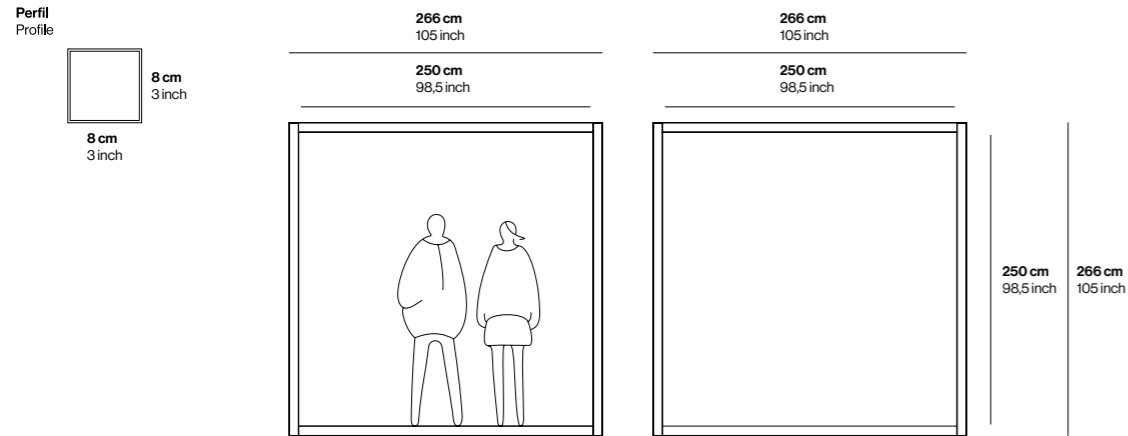

BREZ TRIPLE

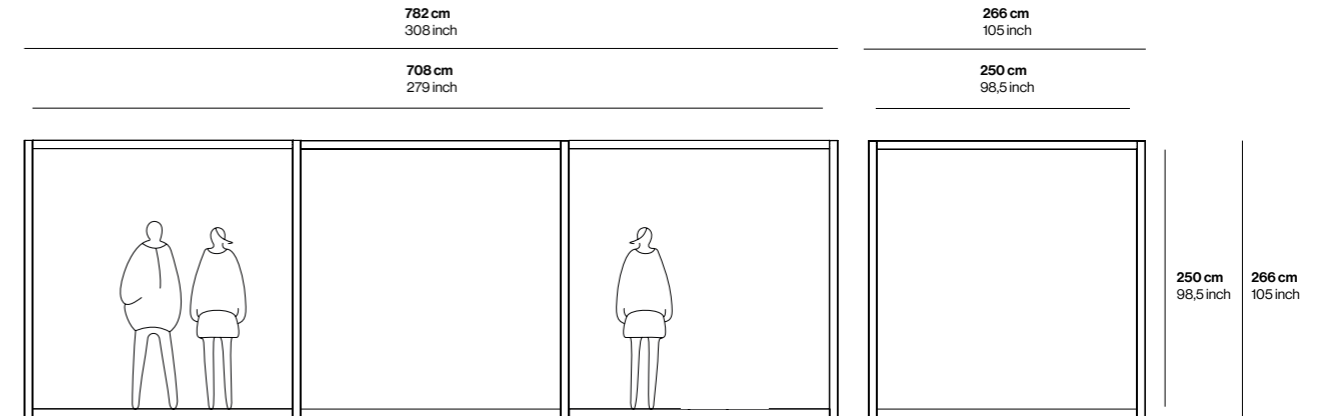

BREZ DOBLE

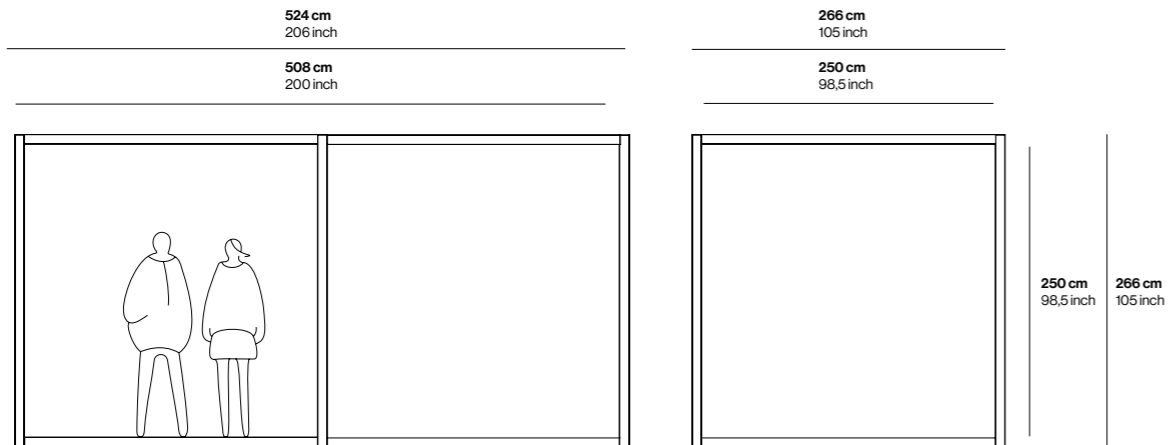

Acabados Finishes

Colores de estructura Structure colors

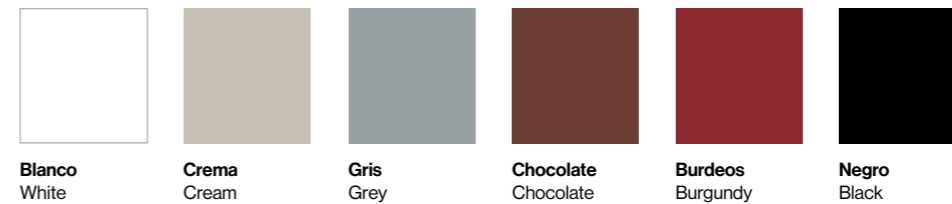

BREZ BIG

Bandada Studio

BREZ BIG SQUARED

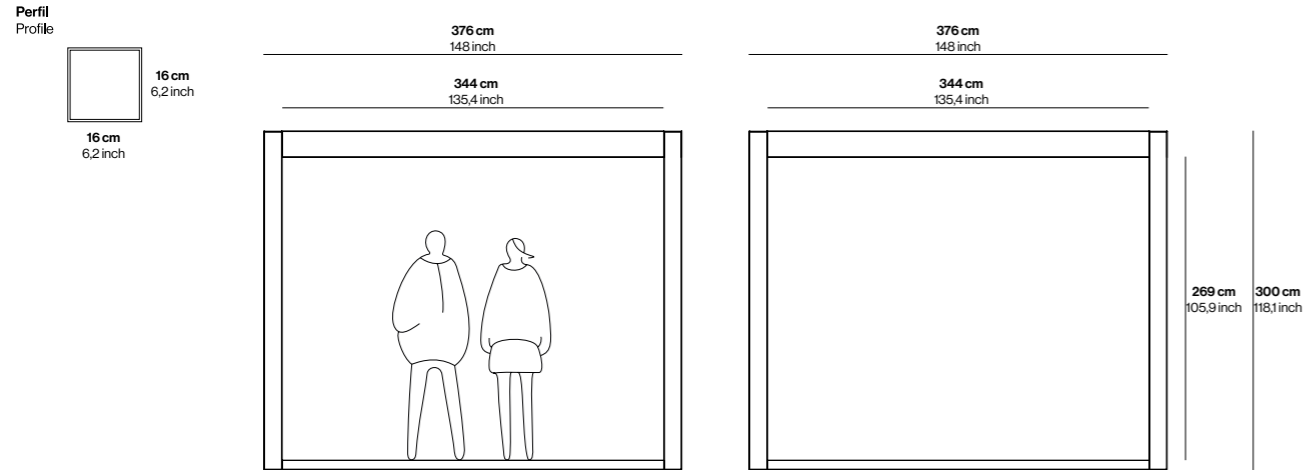

BREZ BIG SIMPLE

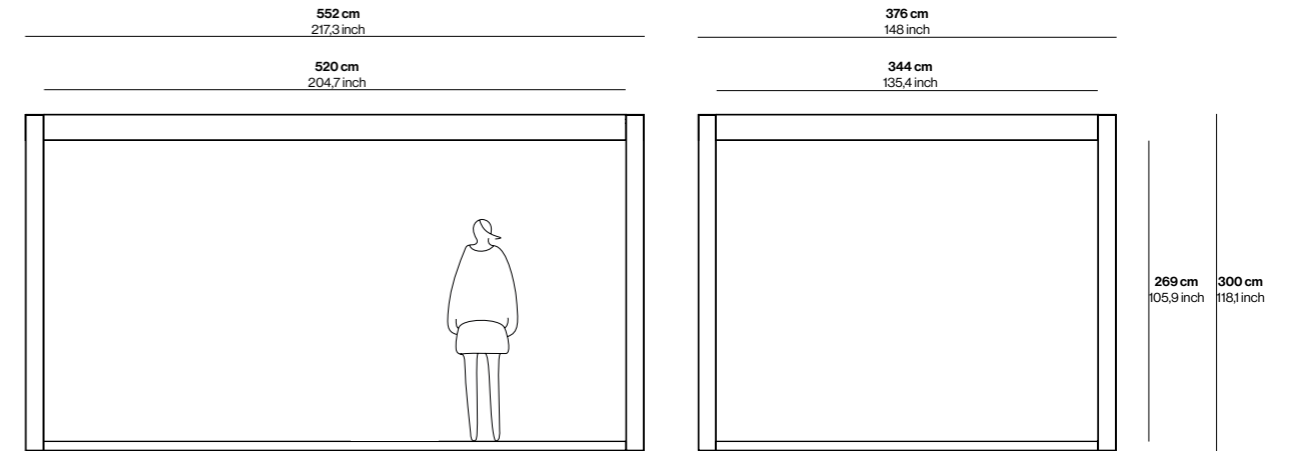

BREZ BIG SQUARED DOBLE

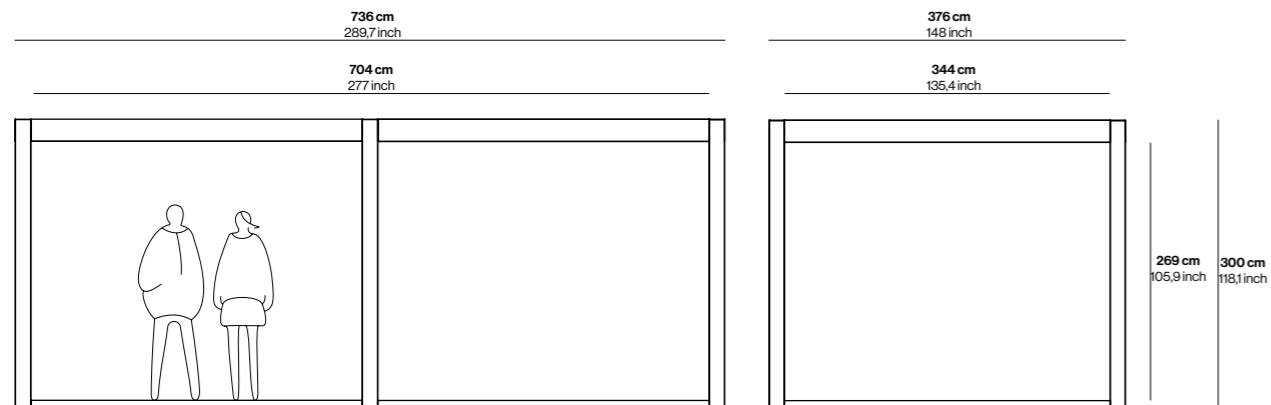

BREZ BIG DOBLE

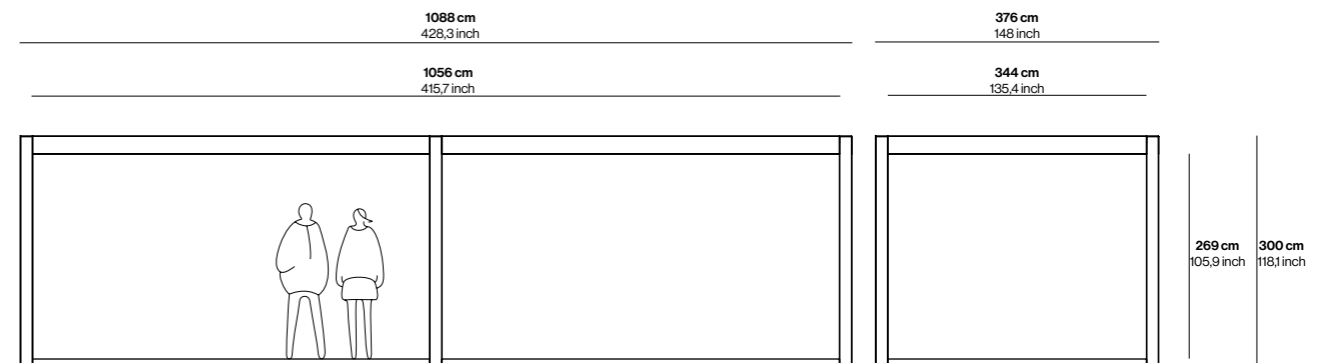

BREZ

Bandada Studio

TECHOS/ROOF



Aluminio/ Aluminum

Techo celosía aluminio / Lattice aluminum roof

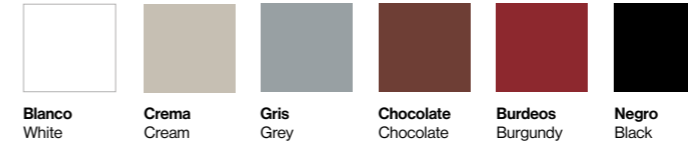

Lona/ Canvas

Techo lona tensa motorizada / Motorized canvas roof

Techo palillera lona / Retractable roof

Soltis 96



Madera/ Wood

Techo celosía madera / Lattice wood roof

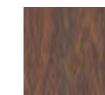

Madera Ipé
Ipé Wood

Aluminio/Aluminium

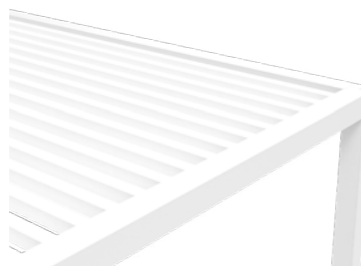

Techo celosía aluminio

Madera/Wood

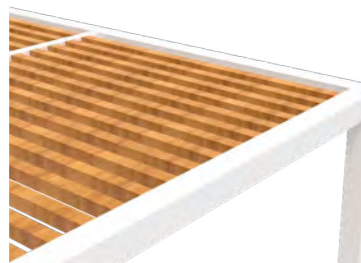

Techo celosía madera

Lona/Canvas

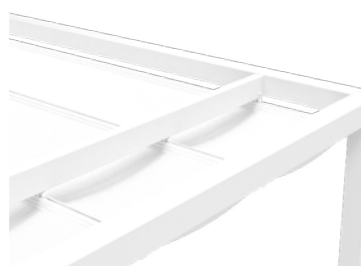

Techo palillera motorizada

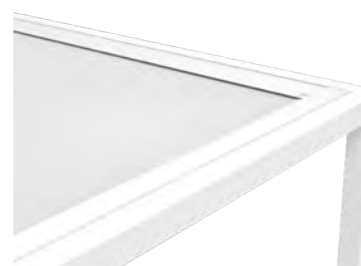

Techo lona tensa motorizada



BREZ

Bandada Studio

CELOSÍA/LATTICE

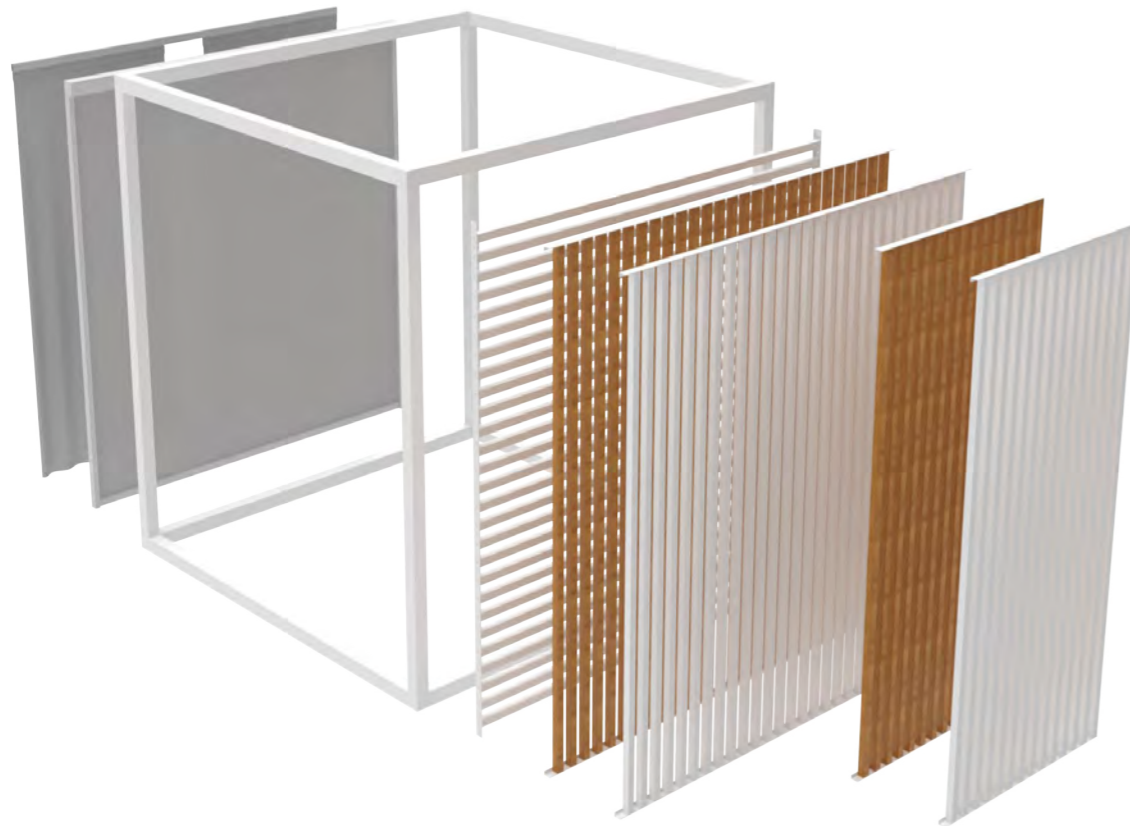

Aluminio/ Aluminum

Panel media celosía aluminio vertical / Half lattice aluminum vertical panel

Panel completo celosía aluminio vertical / Full lattice aluminum vertical panel

Panel completo celosía aluminio horizontal / Full lattice aluminum horizontal panel



Blanco
White

Crema
Cream

Gris
Grey

Chocolate
Chocolate

Burdeos
Burgundy

Negro
Black

Lona/ Canvas

Panel lona tensa motorizada / Motorized canvas panel

Panel cortina manual / Manual curtain panel

Soltis 96



Blanco
96-8102
White
96-8102

Beige
96-50843
Beige
96-50843

Gris
96-2171
Grey
96-2171

Antracita
96-2047
Anthracite
96-2047

Madera/ Wood

Panel media celosía madera vertical / Half lattice wood vertical panel

Panel completo celosía madera vertical / Full lattice wood vertical panel

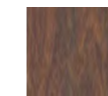

Madera Ipé
Ipé Wood



Panel completo celosía aluminio horizontal

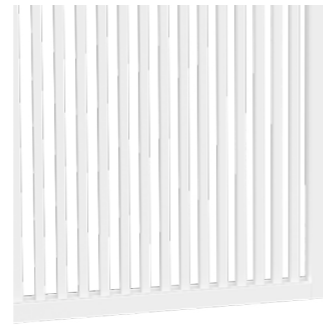

Panel completo celosía aluminio vertical

Aluminio/Aluminium

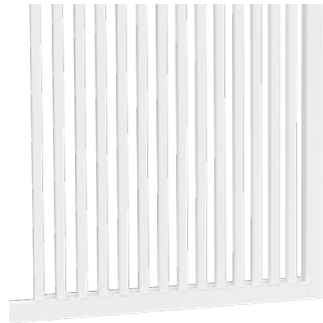

Panel media celosía aluminio vertical



Panel completo celosía madera vertical

Madera/Wood



Panel media celosía madera vertical

Lona/Canvas



Panel cortina manual



Panel lona tensa motorizada

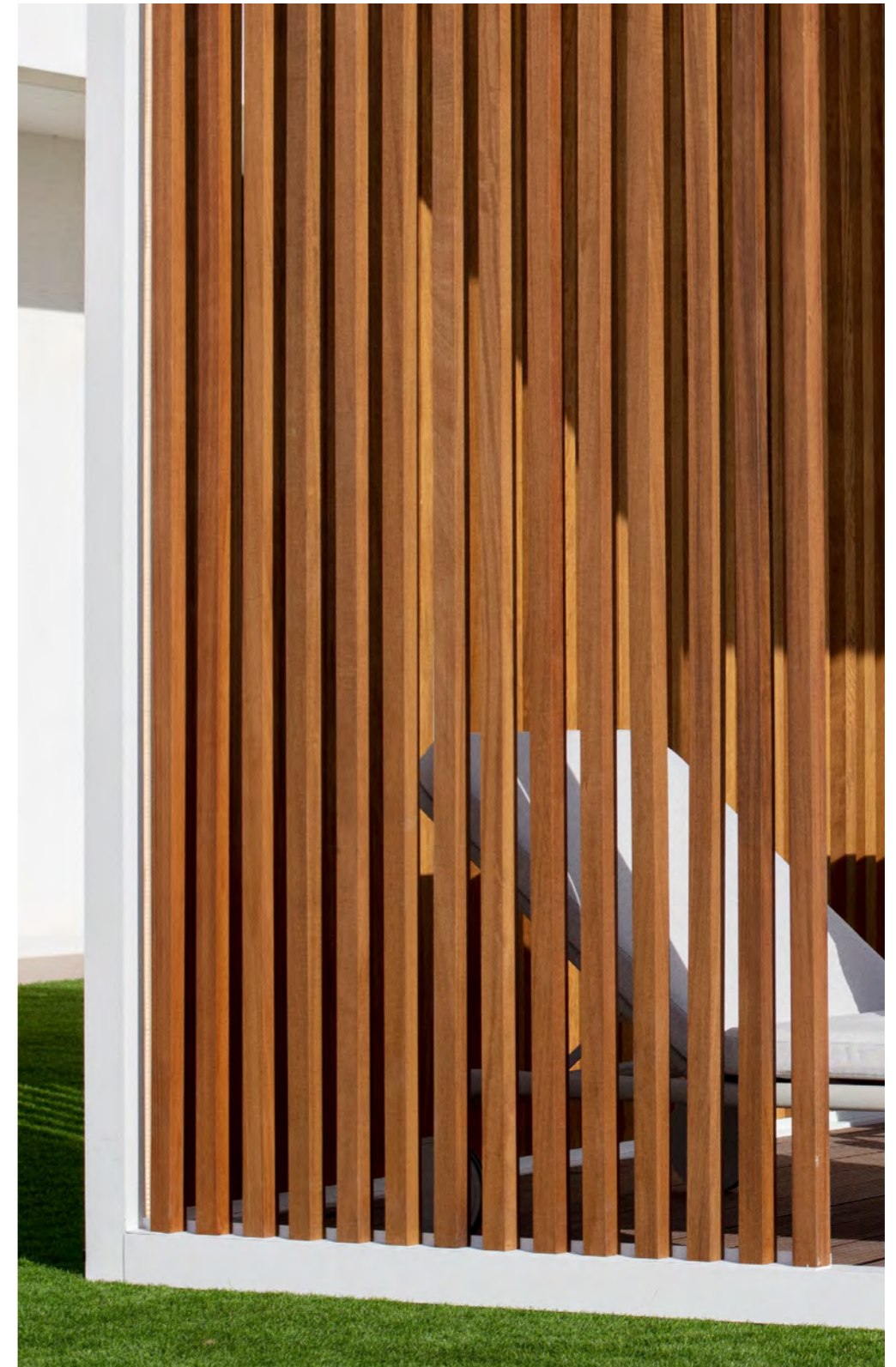

BREZ BIG

Bandada Studio

TECHOS/ROOF

Aluminio/ Aluminium

Techo celosía aluminio / Lattice aluminium roof



Blanco
White

Crema
Cream

Gris
Grey

Chocolate
Chocolate

Burdeos
Burgundy

Negro
Black



Aluminio/Aluminium

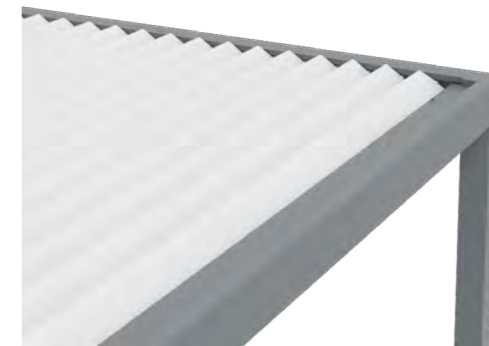

Techo bioclimática

BREZ BIG

Bandada Studio

CELOSÍA/LATTICE

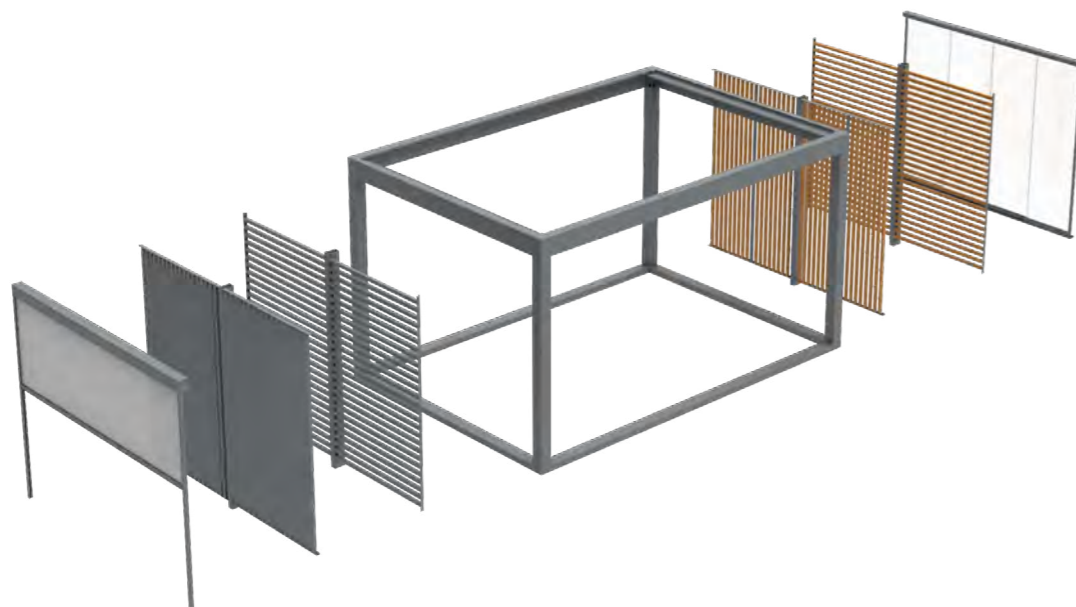
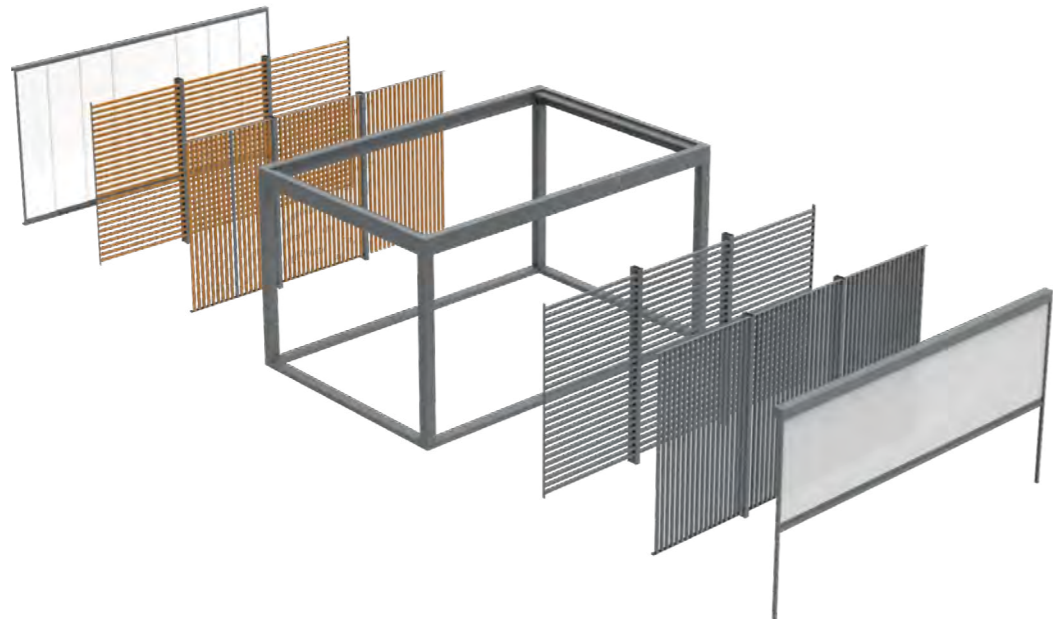

Aluminio/ Aluminum

Panel completo celosía aluminio vertical / Full lattice aluminum vertical panel

Panel completo celosía aluminio horizontal / Full lattice aluminum horizontal panel



Blanco
White

Crema
Cream

Gris
Grey

Chocolate
Chocolate

Burdeos
Burgundy

Negro
Black

Lona/ Canvas

Panel lona tensa motorizada / Motorized canvas panel

Soltis 96



Blanco
96-8102
White
96-8102

Beige
96-50843
Beige
96-50843

Gris
96-2171
Grey
96-2171

Antracita
96-2047
Anthracite
96-2047

Madera/ Wood

Panel completo celosía madera vertical / Full lattice wood vertical panel

Panel completo celosía madera horizontal / Full lattice wood horizontal panel



Madera Ipé
Ipé Wood

Vidrio/ Glass

Panel cortina vidrio corredera / Sliding glass curtain panel



Vidrio
Glass

Aluminio/Aluminium



Panel completo celosía aluminio horizontal

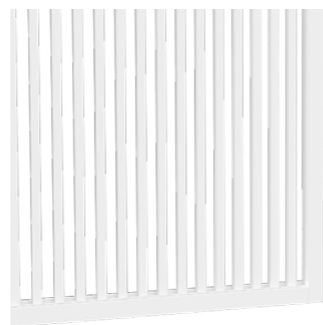

Panel completo celosía aluminio vertical

Vidrio/Glass



Panel cortina vidrio corredera

Madera/Wood



Panel completo celosía madera vertical

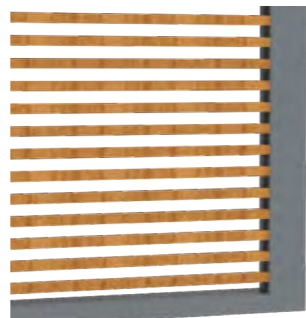

Panel completo celosía madera horizontal

Lona/Canvas



Panel lona tensa motorizada

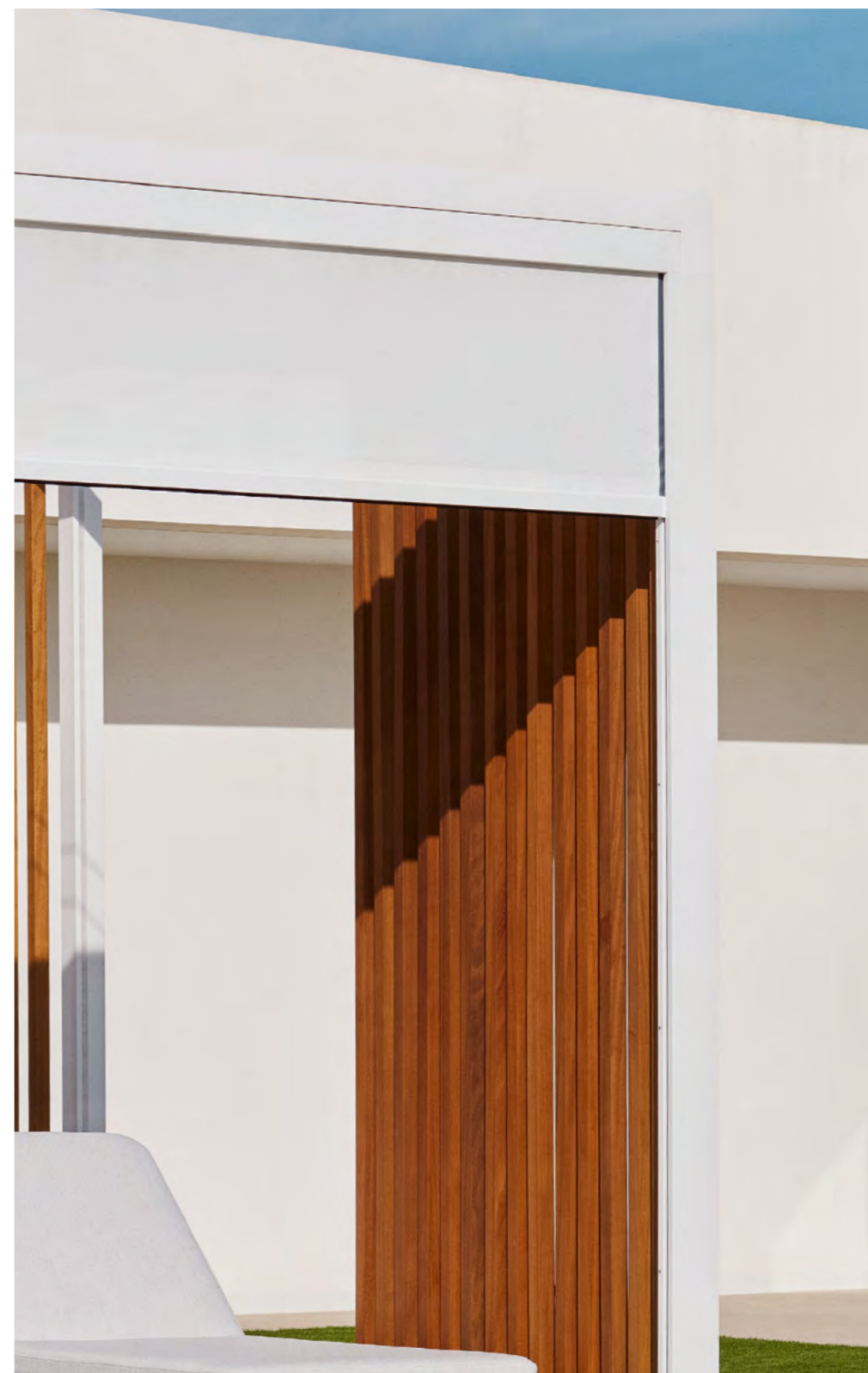

BREZ / BREZ BIG

Bandada Studio

SUELOS/FLOOR

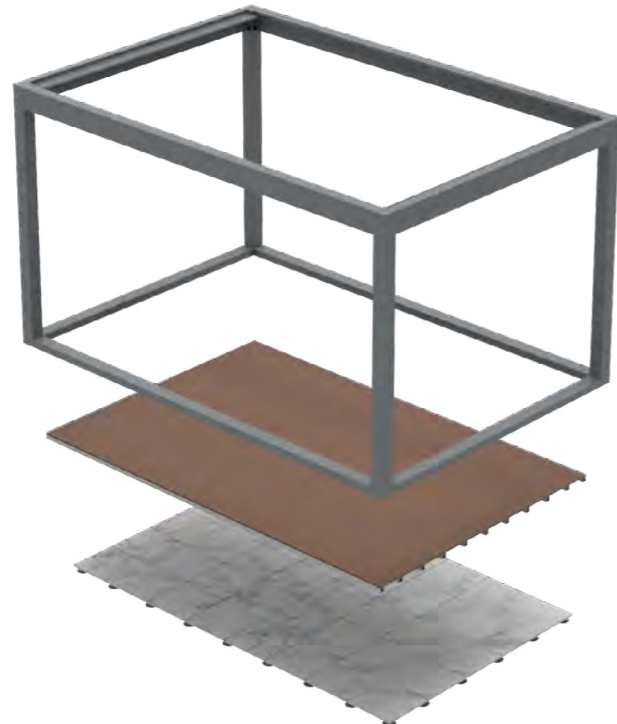

Suelo técnico composite madera / Technical composite floor



Suelo técnico composite madera

Suelo cerámico C3 / Ceramic floor C3

Neolith

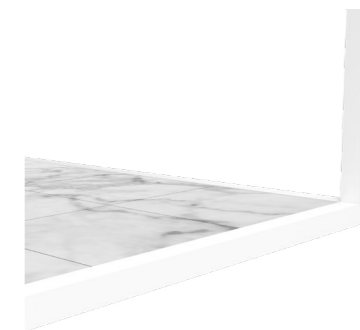

Suelo cerámico C3

COLECCIÓN COLORES

COLORS COLLECTION

ALUMINIO / ALUMINIUM



Blanco White
Crema Cream
Gris Grey
Chocolate Chocolate
Burdeos Burgundy
Negro Black

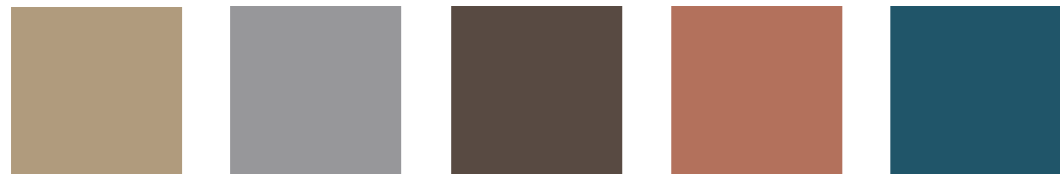

Oro Gold
Plata Silver
Bronce Bronze
Salmón Salmon
Navy Navy

POLIETILENO / POLYETHYLENE



Blanco White
Crema Cream
Gris Grey
Chocolate Chocolate
Burdeos Burgundy
Negro Black

POLIPROPILENO / POLYPROPYLENE



Blanco White
Crema Cream
Gris Grey
Chocolate Chocolate
Burdeos Burgundy
Negro Black

POLIETILENO LACADO / LACQUERED POLYETHYLENE



Blanco White
Crema Cream
Gris Grey
Chocolate Chocolate
Burdeos Burgundy
Negro Black

TABLEROS / TABLETOP

HPL 10 mm

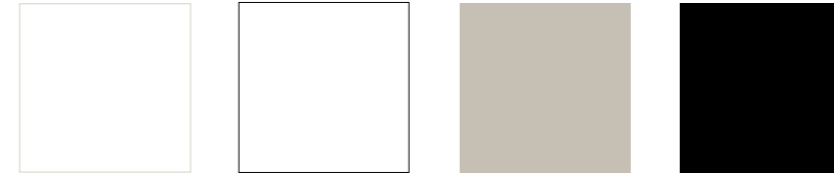

Blanco White
Blanco (borde negro) White (black edge)
Crema Cream
Negro Black

NEOLITH

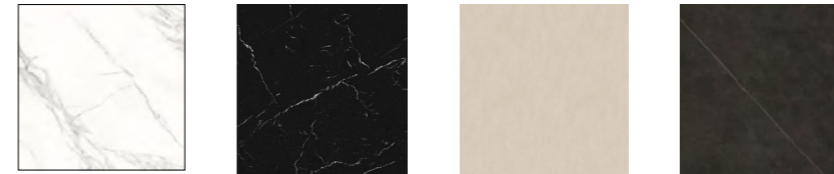

Calacatta Calacatta
Nero Marquina Nero Marquina
Pietra di Oso Pietra di Oso
Calatorao Calatorao

VIDRIO / GLASS



Blanco White
Crema Cream
Negro Black
Natural Ahumado Somked Natural

REPOSABRAZOS / ARMREST

MADERA / WOOD

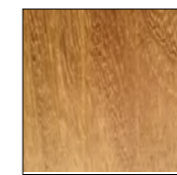

Iroko Iroko

TELAS DE CINTA / TAPE FABRICS

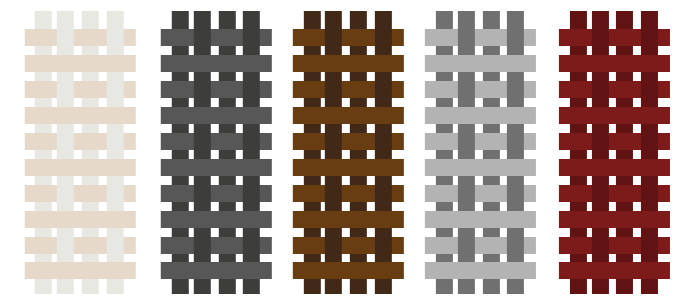

144 marfil 100 sorra
 270 carmelita 303 ceniza
 250 tabaco 124 almendra
 349 ciclón 307 lluvia
 502 priorat 500 granate

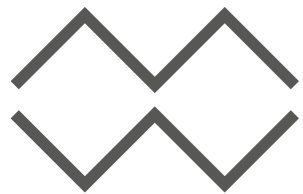

Partida de las Tiesas 493
03400 Villena (Alicante) SPAIN
Tel. +34 966507356
info@mowee.com
www.mowee.com

MW2-22

